

*External wall insulation
specification for
weathering and thermal
bridge control guide.*

August 2024 update including
roofline closure details

Specification for Weathering and Thermal Bridge Control

Foreword

Additional guidance has been introduced in this April 2024 revision to illustrate the process required to enable EWI systems to be robustly terminated at the eaves, verge and other roof line interfaces where extending the roof line (which should always be considered as the best option) might be neither practicable nor possible.

The installation of external wall insulation (EWI) to improve the thermal performance and efficiency of residential and non-residential building has become widespread and is well established in the UK, with many installations over 30 years old, and the approach is recognised as being able to bring significant reductions in heat loss to the walls of buildings as well as contributing to a reduction in CO₂ emissions.

In order for optimum performance to be achieved, external wall insulation systems (a form of so-called 'solid wall' insulation, SWI) should be designed and installed to have good continuity of the insulation with few thermal bridges, and should be detailed to ensure that water penetration from the external environment is prevented so that the insulation layer remains dry, and so that problems associated with water collection in the building fabric do not occur.

This Specification for Weathering and Thermal Bridge Control comprises of a set of design details which have been prepared for use by practitioners of external wall insulation, including Retrofit Designers, Architects, and installers.

The details provided are not exhaustive, but set out the general principles involved to ensure that installed EWI systems address issues of thermal bridging and weather tightness. The details provide guidance only, and are intended to assist designers and other practitioners to differentiate between details which might result in thermal bridging and/or risk of failure due to weather penetration.

The Thermal Bridging elements of these details have evolved from the details provided in support of PAS2030:2017, and have been extended to include guidance on providing weathering resistance.

Those thermal bridging details that are green coded provide a managed control of thermal bridging, whilst those coded as amber have an increased risk of condensation and mould growth associated with them if internal conditions - in terms of ventilation and temperature - are unfavourable. On some wall constructions these amber-coded details may pose no risk but this would need to be proven by the additional undertaking of thermal bridging modelling or by otherwise ensuring that internal humidity levels and ventilation conditions are such that the condensation risk is adequately reduced for the lifetime of the measure.

In all cases, practitioners must make every reasonable endeavour to ensure that thermal bridge free detailing is adopted and should demonstrate that, where green-coded details are not employed, every effort is made to incorporate details that come as close to the green-coded detail as is practicably possible, and the amber-coded details are deemed to satisfy this requirement.

The long term weathering resistance of an installed EWI system is dependent not only on the type and quality of the materials of the system, but also on the detailing and quality of installation.

Effective prevention of water penetration (i.e. weathering resistance) can be achieved by considering the EWI system details, identifying possible modes of failure ('Risks') which would result in water penetration, and providing guidance on how the risks can be reduced or eliminated altogether ('Solutions').

The guidance in this document considers a range of typical construction elements which may be found on most retrofit installation projects and identifies the potential risks as far as weathering are concerned. In each instance, one or more approaches are offered which, if followed, will provide a long lasting and durable weather resistant detail.

In some cases, works to other building elements may be required in order to provide an optimised detail - these can be considered to be 'best practice'. In other cases it is understood that best practice may not be achieved for technical reasons or for reasons of practicability. In these cases, the details provided identify the risks associated with employing a less robust detail. *Building owners and practitioners should be advised that failure to adopt best practice guidance at an early stage may result in higher costs as a result of problems caused by taking an easier route at an early stage.*

Although other details will invariably arise on individual projects and which are not covered within this document, the same underlying principles apply insofar as it is possible to design and install an EWI system that is entirely weather tight and which will provide a satisfactory level of performance for the lifetime of the building onto which it is applied, taking into account necessary inspection and maintenance cycles.

Pre-installation Surveys

Prior to preparing a specification for the installation of EWI on a building it is essential that a detailed survey of the property is carried out by a competent person. Poor assessment of the baseline condition of the building structure can cause problems, or lead to the aggravation of pre-existing conditions and may result in an inappropriate specification for the EWI system being issued.

The survey, which should be completed before the specification is issued should include all of the following:

- The building location
- The relationship of the building being treated with that of adjoining buildings which are to remain untreated.
- Exposure zone for wind driven rain - reference can be made to BRE publication BR 262 'Thermal Insulation: Avoiding Risks'
- Potential sites of thermal bridging - reference can be made to BRE publication FB61 'Reducing thermal bridging at junctions when designing and installing solid wall insulation'
- Proximity to sources of air-borne pollution (e.g. heavy vehicular or rail freight traffic)
- The state of repair of the wall and other related elements (including drainage)
- Sources of moisture (incidences of rising or penetrating damp)
- Ventilation
- Heritage
- Identification of any defects that should be addressed before installation works begin
- Restrictions or obstacles to the installation
- The number, nature, location and identification of all fuel burning appliances (in accordance with the guidance set out in NIA/HHIC publication 'Specification for the installation of external wall insulation ensuring the safety and operation of fuel burning appliances V.1.0 31st March 2017')

The information collected during the survey will inform the EWI system specification and design which should include all interface, edge and abutment details for which a weathering-critical solution is required, and details which address all potential thermal bridging sites.

Appropriate weathering and thermal bridging control details should then be provided to the installation teams to ensure that the system is installed to achieve optimum performance. Appropriate checks and inspections should be carried out during the installation, and after its completion, to ensure that all of the details have been installed correctly and that the system is appropriately sealed, all in accordance with the details and specification.

No installation work should be undertaken until all of the specified information has been obtained and confirmed.

Installation Operatives / Technicians

To attain a level of competence, EWI technicians/installation operatives must have successfully completed a training course covering all matters referred to in this guide. Trained operatives and their supervisors must be able to demonstrate that they are able to read and understand the detail drawings so that the details supplied by the EEM designer, Architect and/or EWI system designer can be correctly constructed on site.

EWI installation operatives should not undertake works associated with combustion fuel appliances. Works such as removal and re-instatement of condensate drains, modification to pressure relief valve (PRV) discharge pipes etc., may be carried out by another competent person such as a plumber, but if any doubt exists then a Gas Safe registered engineer or other competent person should be consulted.

Legal Requirements

The main legal requirements for protection of the public and employees are the general provisions of the Health and Safety at Work Act 1974, and related legislation, including the Management of Health and Safety at Work Regulations 1999. These require the drawing up of a 'risk assessment' and plan of protective measures, as well as the appointment of competent persons to ensure that safety requirements are met effectively.

Responsibilities of EWI/SWI System Installers

Where inadequate design and/or installation occurs EWI systems are more vulnerable to installation defects such as poor water tightness, which can lead to the insulation becoming waterlogged or even to water entry into the building, or thermal bridging which can result in dampness and mould growth on internal surfaces.

EWI installers have the responsibility for ensuring that upon completion of the EWI/SWI installation the system is adequately sealed, robust, thermal- and weather-tight. Installers must leave flues, chimneys, combustion air ventilators, and any other items relating to the safe operation of gas appliances in the same (or better) condition than before the EWI installation took place.

Furthermore, if during EWI installation work, faults are identified which could harm the occupants or installation operatives, or if any gas pipework is damaged or disturbed, appropriate action must be taken to safeguard people's health and well-being: Seek immediate advice from a Gas Safe registered engineer and/or contact the Gas Emergency Service.

Sealants

In this guidance the use of sealants (mastics, caulking) as the sole means of providing a weather tight seal between an exterior rendered surface and its abutment to another material is not accepted, in line with PAS rules. In all cases, sealants should only be used in conjunction with an appropriate backing material, such as a compressed hydrophobic tape or proprietary backing rod.

Where sealants are employed to provide a barrier to water penetration (e.g. at service penetrations, etc.) the choice of sealant type must take into account the varying movement capabilities of the sealant material, its UV resistance, adhesion properties, and its compatibility with the materials of the surfaces against which it will be applied. The use of the wrong sealant type for a particular application can result in failure regardless of other factors, and failure can contribute to water penetration at the joint. In all cases where sealants are employed as an outer /external seal, a suitable backing rod or tape must be employed in addition to the sealant.

Sealants should be as specified by the EWI system supplier to ensure compatibility with the render system. Where no recommendation is made by the EWI system supplier guidance on the selection of an appropriate sealant can be found in BS 6213. Sealants should generally be low-modulus elastic types since these are more suitable where constant movement is likely. The long term performance of the sealant should be confirmed by the manufacturer.

Sealing Tapes

Sealing tapes are pre-compressed, expanding foam tapes that are used to provide a permanently elastic weather seals at junctions and abutments. They usually have a self-adhesive backing which makes installation quick, easy and clean and they can be used to seal against the contours of irregular or uneven surfaces. Being permanently elastic, sealing tapes allow for continual expansion and contraction and when fitted under compression, sealing tapes are fully weather resistant and can protect against wind-driven rain.

Sealing tapes can be hydrophobic/water repellent, although the hydrophobic quality of the material is less of a consideration than whether it is an open cell or closed cell foam. Only closed cell foam sealing tapes should be used for weather protection applications - the closed cell structure provides better water sealing properties.

Where joining of adjacent lengths of sealing tape is required to provide a continuous seal, the ends of the tapes should be neatly cut and the ends should be overlapped by about 25 mm. Butted joints should not be used.

Beads, Trims, Flashings

The weathering resistance of beads trims and flashings will depend on the type of material and the conditions that the material is exposed to.

Roofline closure systems

The details in this guide cover the most common roofline closure situations however it is likely that other details will be required. If the situation is not covered in the standard details enclosed, additional details may be developed subject to them meeting the minimum roofline closure principles listed in this document and use of the minimum specification for the materials. Follow the roofline closure systems process map provided by the system designer.

To comply with the guidance, a survey of the existing roofline is required using the roofline survey form, from this survey, a design is produced by the system designer. The installer is required to have proof of training from the system designer for the roofline detail being fitted.

During installation, the roofline closure checklist (provided) should be followed and filled in, adding pictorial evidence starting with the existing roofline condition prior to treatment. These documents will be required for submission to the Retrofit Co-ordinator, Trustmark and the guarantee provider. The material specification for the trim must meet the minimum specification set out by the guidance.

Exposure to sunlight / UV

Metals for trims and flashings are usually aluminium alloy or stainless steel, both of which are unaffected by UV exposure. However, the coatings applied to metals (e.g. polyester powder coatings) will suffer a loss of colour and gloss as a result of prolonged UV exposure.

PVC components that are exposed to sunlight will, to a lesser or greater extent (depending on the purity of the PVC and the presence or absence of UV-absorbing additives) exhibit some surface chalking and discoloration for as long as the exposure persists. Prolonged exposure will also cause the material to lose some of its resistance to impact - the material may become weak and brittle.

Effect of temperature changes

All materials expand and contract with changes in temperature, but PVC has a higher coefficient of linear thermal expansion than that of aluminium or stainless steel. Large, unreinforced, PVC components, such as oversills, will expand and contract more than similar components fabricated from aluminium or stainless steel.

It is important that EWI system abutments to metal and PVC components (e.g. window sills, window frames, oversills, etc.) include flexible, elastic, weather seals, such as compressible tapes, to ensure that weather resistance is maintained even as the PVC or metal expands or contracts due to temperature changes.

In the case of PVCu components, which tend to be much thicker than their metal counterparts, temperature differences across the thickness can also result in significant bowing, so the use of PVC-U components in exposed locations should be considered with care, and sealing tapes should be sized to accommodate the greater degree of movement that PVCu components are likely to exhibit.

Note: For clarity and to avoid duplication, details for working around flue penetrations and other fuel burning appliances and associated fixtures and fittings have been omitted. Reference should be made to the following document for guidance in relation to these areas:

Specification for the installation of external wall insulation ensuring the safety and operation of fuel burning appliances.

THERMAL BRIDGING RISK LEVEL

Note :

- All details indicate fixings that are thermally broken.
- Detail can only be adopted where ground conditions allow. If the ground is a hard surface, pathway or if existing drainage will be disturbed the detail can be difficult to achieve and not practicably possible.
- Detail not allowed where frame thickness allows for reveal insulation



Green, no effect on risk level.

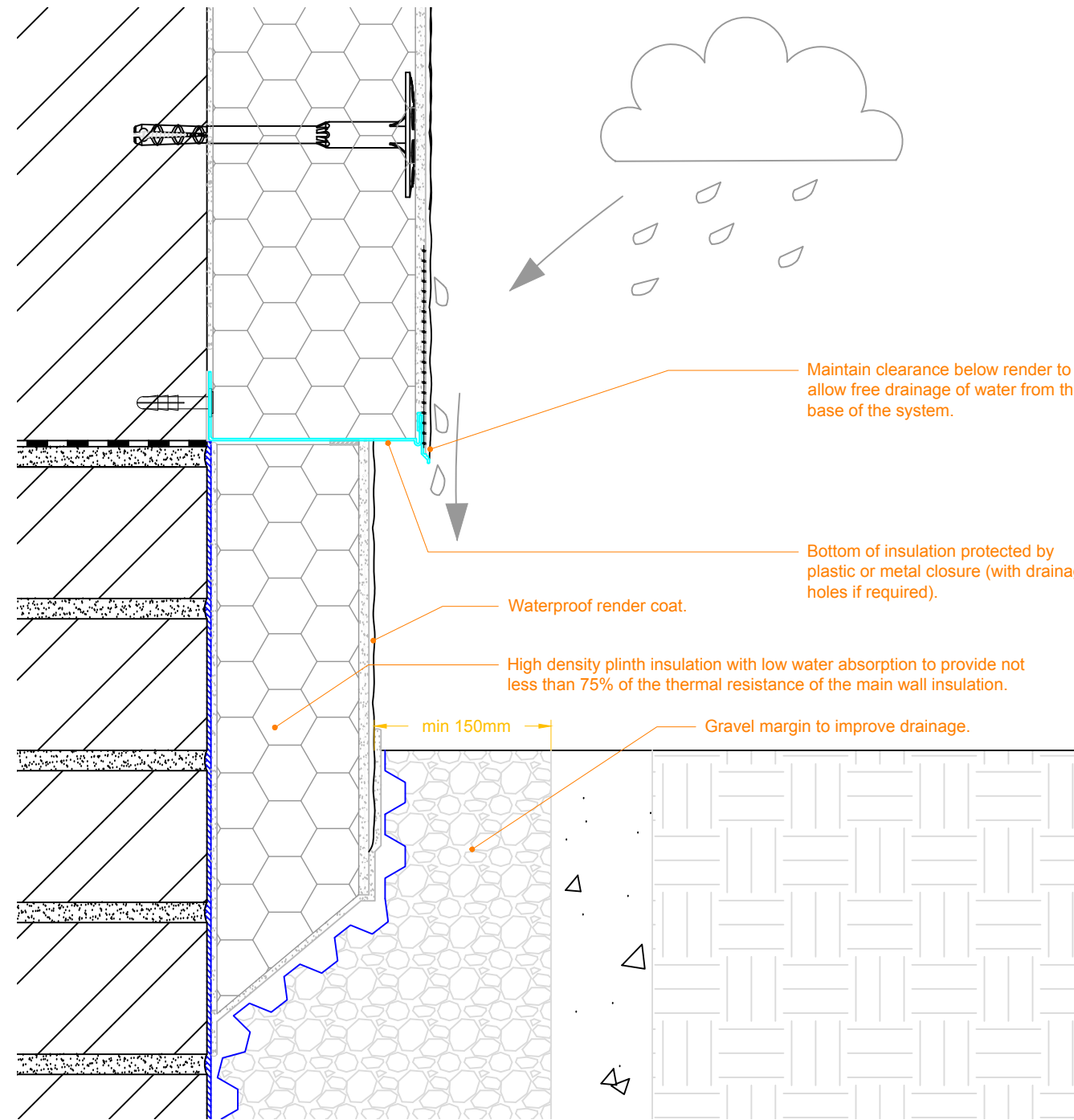

WEATHERING RISK

Risks: Inadequate free drainage of water from the bottom of the render prevents render surface from drying.

Solutions:

- Maintain a clear gap between the bottom edge of the render and the surface below. Bottom of the system protected by a plastic (low thermal conductivity) or metal starter track/base track.

| | |
|----------|------------------|
| Title: | Insulated Plinth |
| Dwg. No. | WRD-B001 |
| Rev. | - |
| Date: | 18/12/2018 |

SPECIFICATION FOR WEATHERING AND THERMAL BRIDGE CONTROL

THERMAL BRIDGING RISK LEVEL

Note :

- All details indicate fixings that are thermally broken.



Green if insulation has same thickness or same thermal resistance as main wall insulation.



Amber if insulation has a thickness or thermal resistance of at least 75% of main wall insulation. Note that amber will increase the assessed inherent technical risk level in table B2 of PAS 2035 by 1

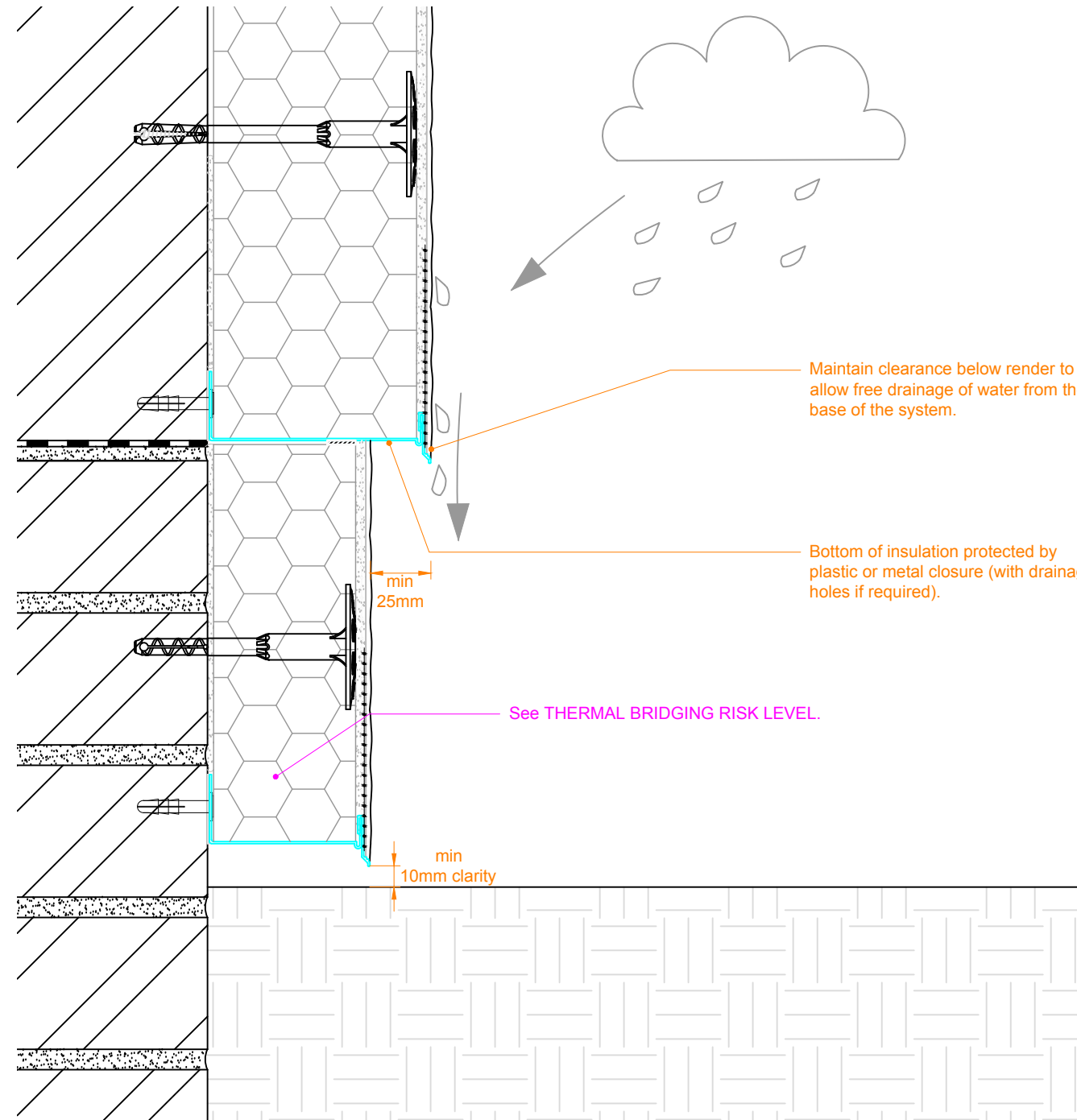

WEATHERING RISK

Risks: Inadequate free drainage of water from the bottom of the render prevents render surface from drying.

Solutions:

- Maintain a clear gap between the bottom edge of the render and the surface below. Bottom of the system protected by a plastic (low thermal conductivity) or metal starter track/base track.

| | |
|----------|----------------------------|
| Title: | Partially-insulated Plinth |
| Dwg. No. | WRD-B002 |
| Rev. | - |
| Date: | 18/12/2018 |

SPECIFICATION FOR WEATHERING AND THERMAL BRIDGE CONTROL

THERMAL BRIDGING RISK LEVEL



Green, no effect on risk level.

Captions :

- ① Insulation should have a thermal resistance of not less than 0.6 m²K/W. Common practice is to over sail the main insulation board past the reveal by 20 mm and adhesively fix the reveal insulation within the remaining recess.

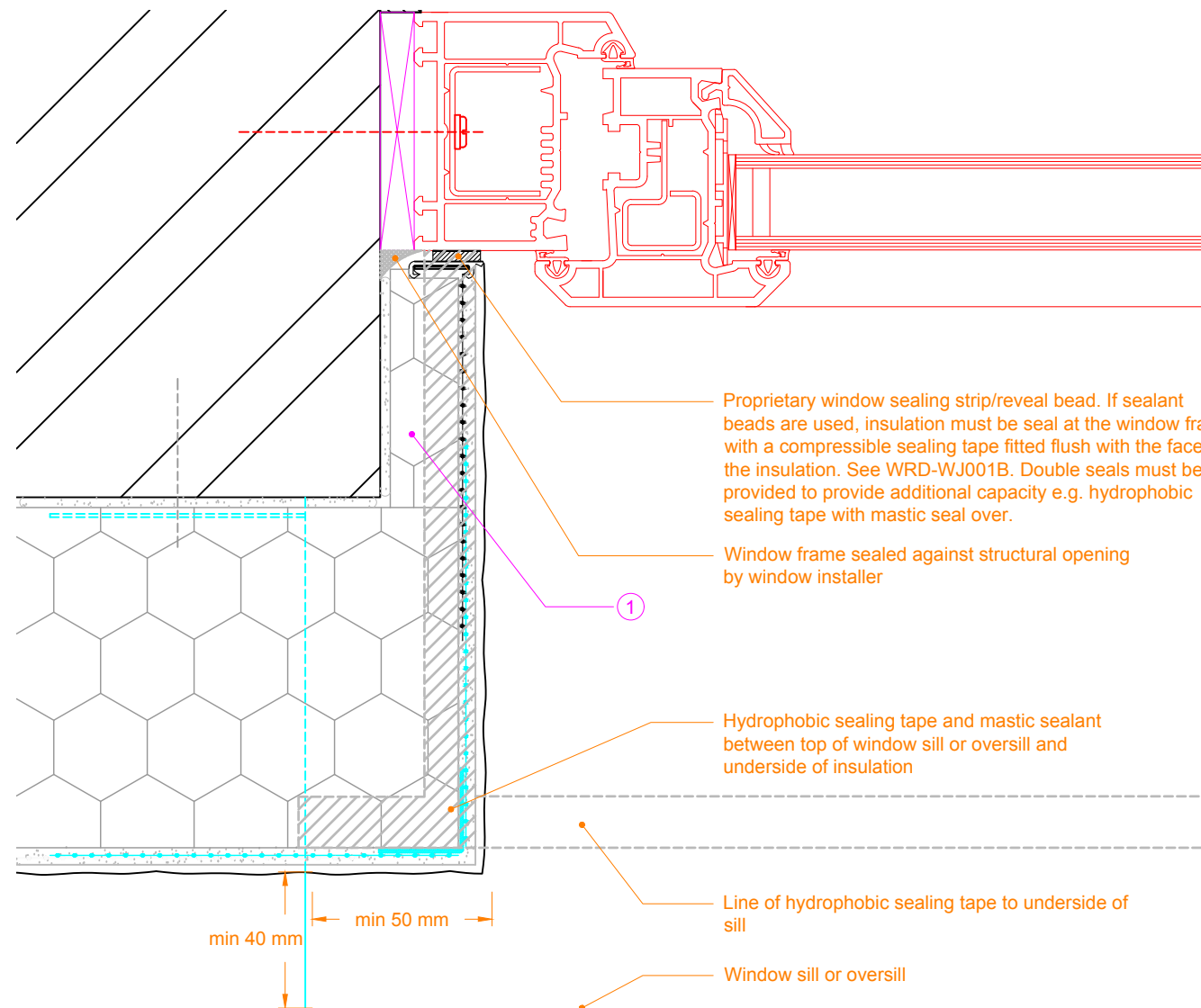

WEATHERING RISK

Risks: Water penetration into EWI system or building at window reveal.

Solutions:

- Windows frame sealed against structural opening and weathertight prior to installation of the EWI system.
- EWI system sealed against window frame at jamb using proprietary window sealing strip/reveals bead.
- EWI sealed against window sill/oversill with fully compressed hydrophobic sealing tape and mastic sealant.
- Designers should consider the use of sills with greater projection where exposure is Zone 4/very severe (BR262).

| | |
|----------|--|
| Title: | Insulation to Recessed Reveal - with Proprietary Window Sealing Strip/Reveals Bead |
| Dwg. No. | WRD-WJ001A |
| Rev. | - |
| Date: | 18/12/2018 |

THERMAL BRIDGING RISK LEVEL

● Green, no effect on risk level.

Captions :

- ① Insulation should have a thermal resistance of not less than 0.6 m²K/W. Common practice is to over sail the main insulation board past the reveal by 20 mm and adhesively fix the reveal insulation within the remaining recess.

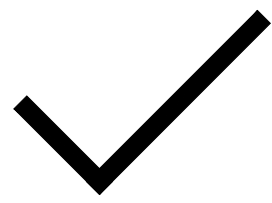
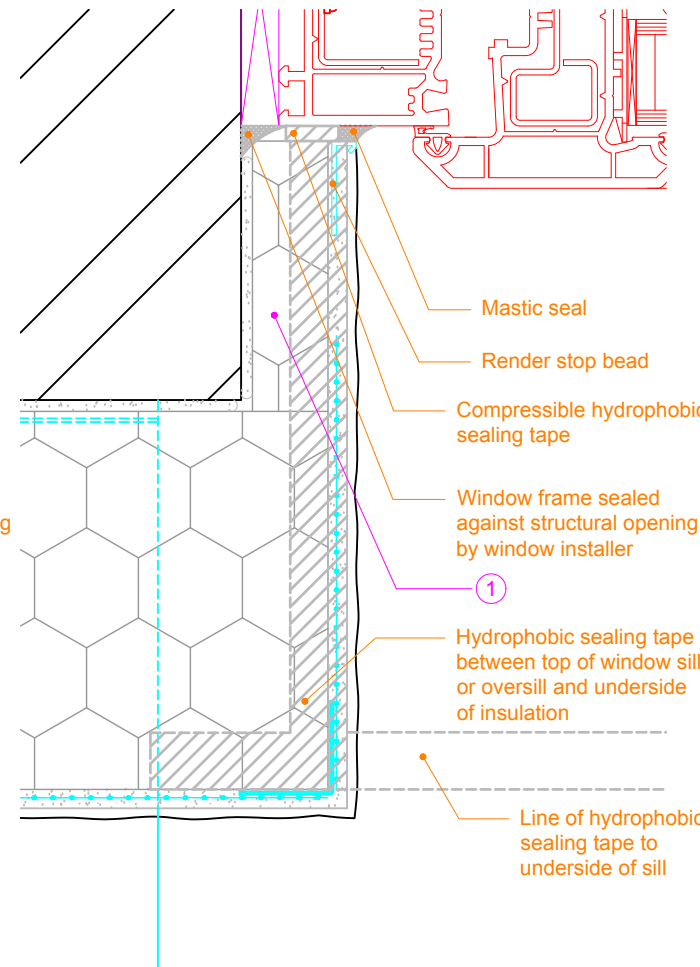
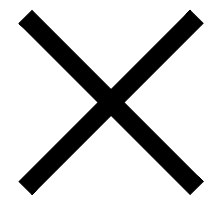
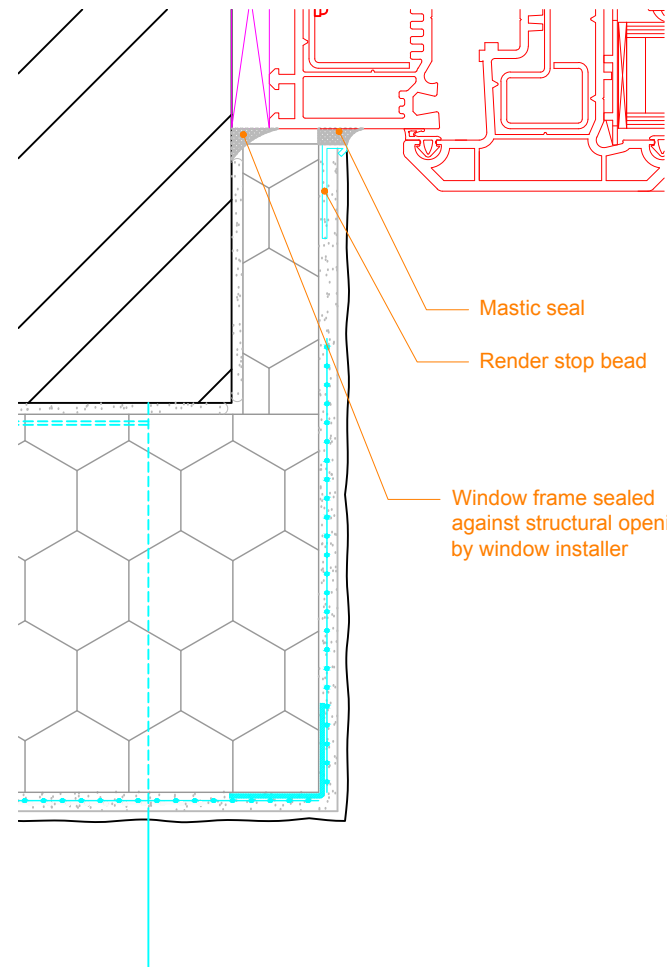

WEATHERING RISK

Risks: Water penetration into EWI system or building at window reveal.

Solutions:

- Windows frame sealed against structural opening and weathertight prior to installation of the EWI system.
- EWI system sealed against window frame at jamb using proprietary window sealing strip/reveals bead.
- EWI sealed against window sill/oversill with fully compressed hydrophobic sealing tape and mastic sealant.

| | |
|----------|---|
| TITLE: | Insulation to Recessed Reveal - with Render Stop Bead and Mastic Seal |
| Dwg. No. | WRD-WJ001B |
| Rev. | - |
| Date: | 18/12/2018 |

SPECIFICATION FOR WEATHERING AND THERMAL BRIDGE CONTROL

THERMAL BRIDGING RISK LEVEL

Note :

- All details indicate fixings that are thermally broken.



Green, no effect on risk level.

Captions :

- ① Insulation should have a thermal resistance of not less than 0.6 m²K/W. Common practice is to over sail the main insulation board past the reveal by 20 mm and adhesively fix the reveal insulation within the remaining recess.

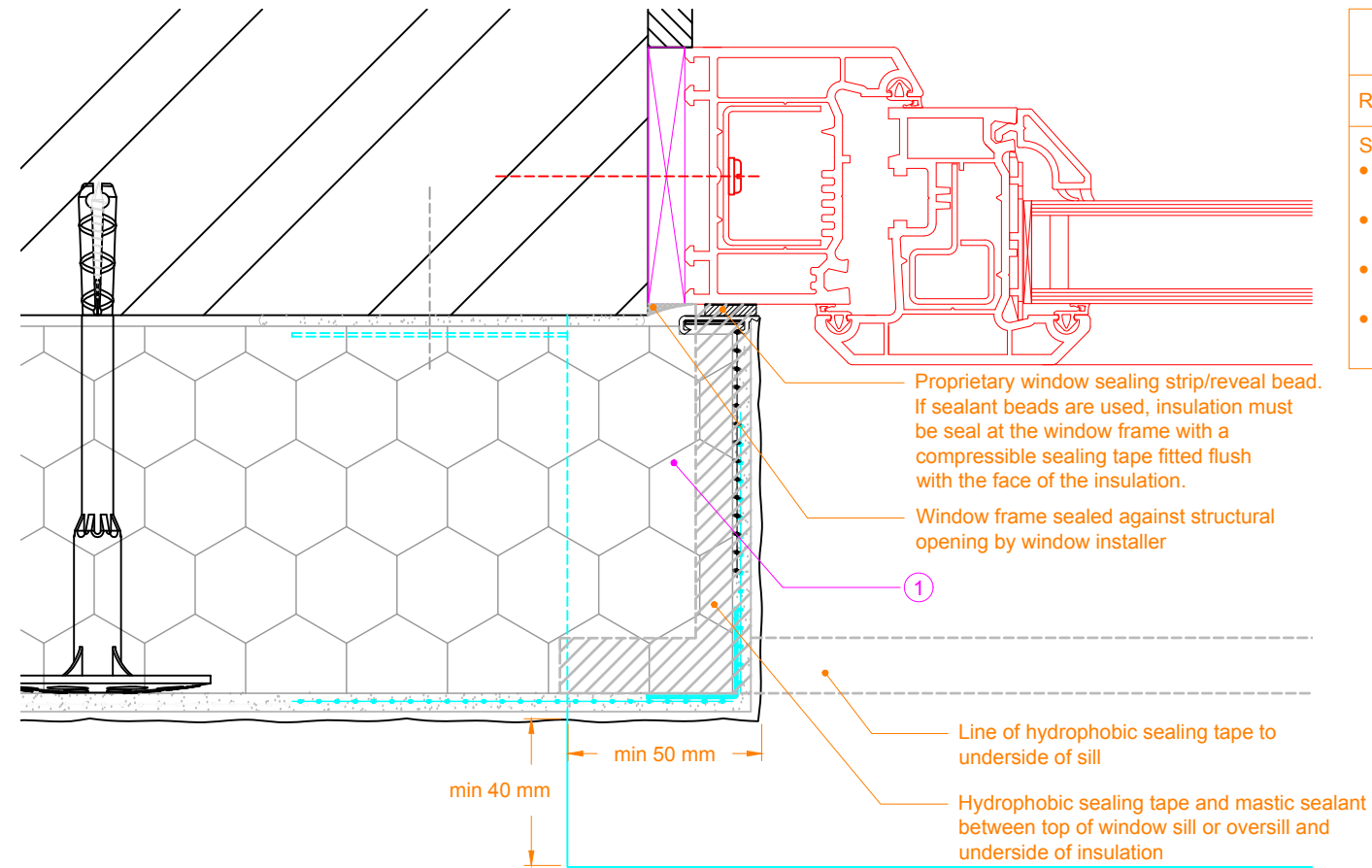

WEATHERING RISK

Risks: Water penetration into EWI system or building at window reveal.

Solutions:

- Windows frame sealed against structural opening and weathertight prior to installation of the EWI system.
- EWI system sealed against window frame at jamb using proprietary window sealing strip/reveals bead.
- EWI sealed against window sill/oversill with fully compressed hydrophobic sealing tape and mastic sealant.
- Designers should consider the use of sills with greater projection where exposure is Zone 4/very severe (BR262).

| | |
|----------|---|
| TITLE: | Insulation over Flush Reveal - with Proprietary Window Sealing Strip/Reveals Bead |
| Dwg. No. | WRD-WJ002 |
| Rev. | - |
| Date: | 18/12/2018 |

SPECIFICATION FOR WEATHERING AND THERMAL BRIDGE CONTROL

THERMAL BRIDGING RISK LEVEL

Note :

- All details indicate fixings that are thermally broken.
- Detail not allowed where frame thickness allows for reveal insulation



Amber if wall constructed in ≥ 225 mm solid brick. Not suitable for random stone constructions. Note that amber will increase the assessed inherent technical risk level in table B2 of PAS 2035 by 1.

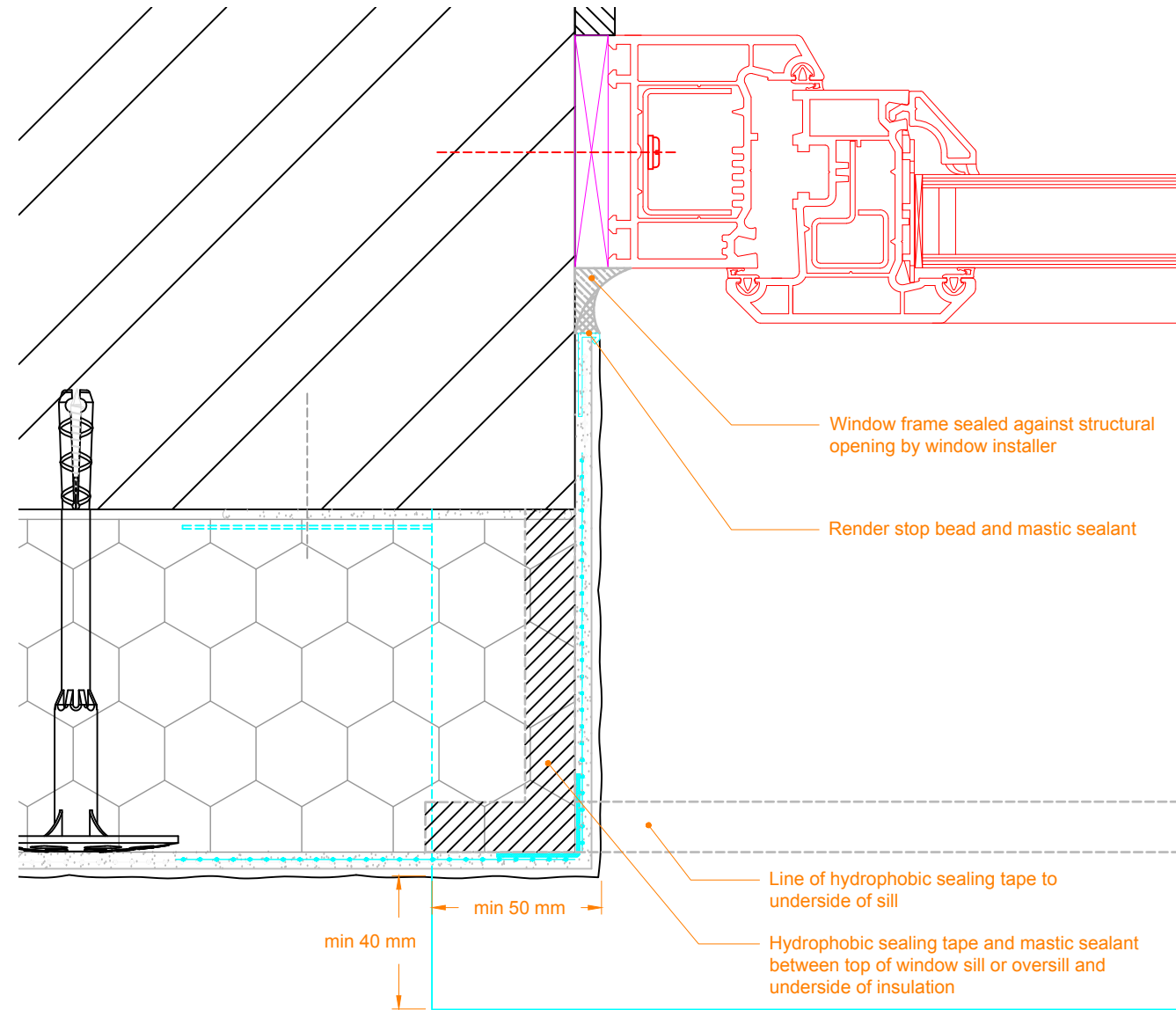

WEATHERING RISK

Risks: Water penetration into EWI system or building at window reveal.

Solutions:

- Windows frame sealed against structural opening and weathertight prior to installation of the EWI system.
- EWI system sealed against window frame at jamb using proprietary window sealing strip/reveals bead.
- EWI sealed against window sill/oversill with fully compressed hydrophobic sealing tape and mastic sealant.
- Designers should consider the use of sills with greater projection where exposure is Zone 4/very severe (BR262).

| | |
|----------|-----------------------------|
| Title: | Un-Insulated Reveal at Jamb |
| Dwg. No. | WRD-WJ003 |
| Rev. | - |
| Date: | 18/12/2018 |

THERMAL BRIDGING RISK LEVEL

Note :

- All details indicate fixings that are thermally broken.



Green, no effect on risk level.

Captions :

- ① Window frame and sill to be thermally broken.

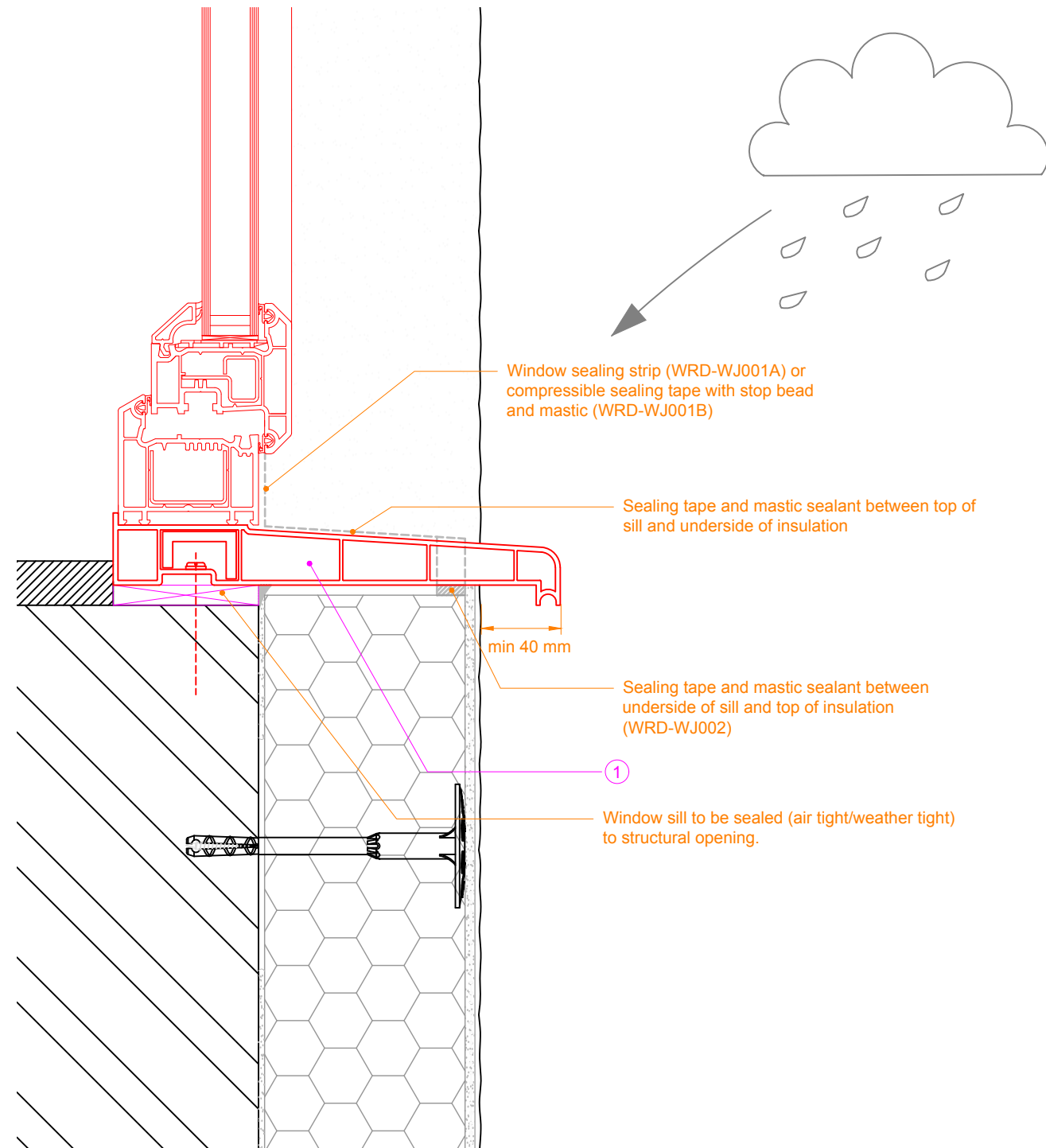

WEATHERING RISK

Risks:

- Window sill projection insufficient to provide effective water shedding.
- Differential thermal movement at render abutment to sill may allow water ingress.

Solutions:

- Windows sill and frame sealed against structural opening and weathertight prior to installation of the EWI system.
- EWI system sealed against window sill/oversill with fully compressed hydrophobic sealing tape and mastic sealant.
- Window sill to provide min 40 mm projection from face of render. *
- If window sill projection is insufficient, provide suitable over- or under-sill (see WRD-WS003).
- Designers should consider the use of sills with greater projection where exposure is Zone 4/very severe (BR262).

* See BSEN13914-1:2016 Design, preparation and application of external rendering and internal plastering. External rendering.

| | |
|----------|-------------------------------|
| TITLE: | New Window with Extended Sill |
| Dwg. No. | WRD-WS001 |
| Rev. | - |
| Date: | 18/12/2018 |

SPECIFICATION FOR WEATHERING AND THERMAL BRIDGE CONTROL

THERMAL BRIDGING RISK LEVEL

Note :

- All details indicate fixings that are thermally broken.



Green, no effect on risk level.



Amber if non-thermally broken sill. Note that amber will increase the assessed inherent technical risk level in table B2 of PAS 2035 by 1.

Captions :

- ① Window frame and sill to be thermally broken. All sills should have end caps and be fixed using either mechanical fixings with plastic caps or high strength adhesives.

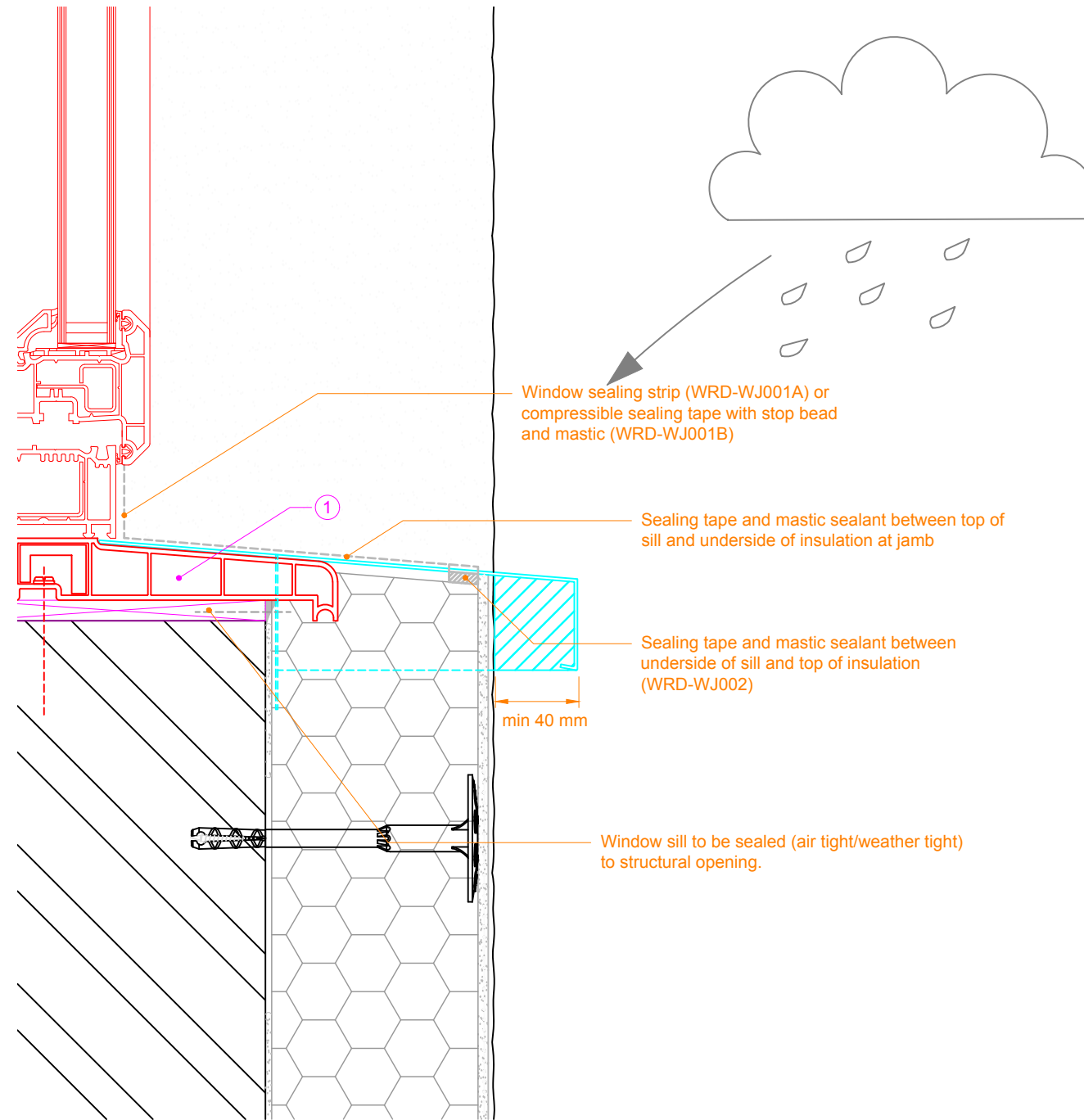

WEATHERING RISK

Risks:

- Window sill projection insufficient to provide effective water shedding.
- Differential thermal movement at render abutment to sill may allow water ingress.

Solutions:

- Windows sill and frame sealed against structural opening and weathertight prior to installation of the EWI system.
- EWI system sealed against window sill/oversill with fully compressed hydrophobic sealing tape and mastic sealant.
- Window sill to provide min 40 mm projection from face of render.*
- If window sill projection is insufficient, provide suitable over- or under-sill (see WRD-WS003) with min. 40 mm projection.
- Designers should consider the use of sills with greater projection (50 mm) where exposure is Zone 4/very severe (BR262).
- System should be sealed against the frame by means of a hydrophobic tape and mastic or proprietary stop bead with integral hydrophobic tape.
- Ensure that any existing drainage holes are not blocked, or install new drainage holes.

* See BSEN13914-1:2016 Design, preparation and application of external rendering and internal plastering. External rendering.

| | |
|----------|-------------------------------|
| Title: | Existing Window with Oversill |
| Dwg. No. | WRD-WS002 |
| Rev. | - |
| Date: | 18/12/2018 |

THERMAL BRIDGING RISK LEVEL

See WRD-WS002

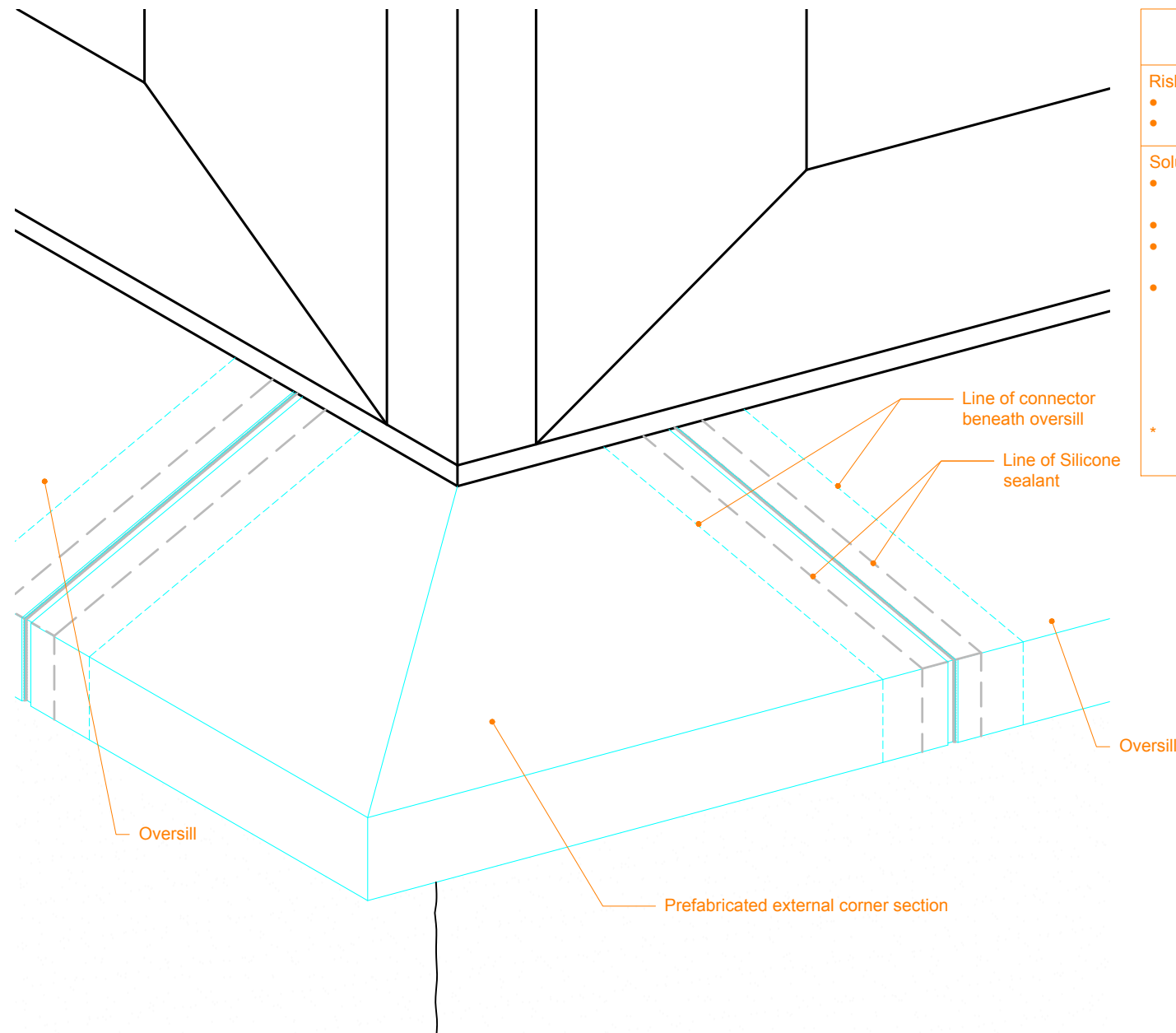

WEATHERING RISK

Risks:

- Window sill projection insufficient to provide effective water shedding.
- Water penetration at unsealed joint.

Solutions:

- Windows sill and frame sealed against structural opening and weathertight prior to installation of the EWI system.
- Oversill to provide min 40 mm projection from face of render.*
- Designers should consider the use of sills with greater projection (50 mm) where exposure is Zone 4/very severe (BR262).
- Adjacent sill sections joined together with metal connectors with seals on both sides of the joint.

* See BSEN13914-1:2016 Design, preparation and application of external rendering and internal plastering. External rendering.

| | |
|----------|--|
| TITLE: | Oversill External Corner : Polyester Powder Coated Aluminium |
| Dwg. No. | WRD-WS003 |
| Rev. | - |
| Date: | 18/12/2018 |

SPECIFICATION FOR WEATHERING AND THERMAL BRIDGE CONTROL

THERMAL BRIDGING RISK LEVEL

Note :

- All details indicate fixings that are thermally broken.



Green, no effect on risk level.



Amber if non-thermally broken sill. Note that amber will increase the assessed inherent technical risk level in table B2 of PAS 2035 by 1.

Captions :

- ① Window frame and sill to be thermally broken.

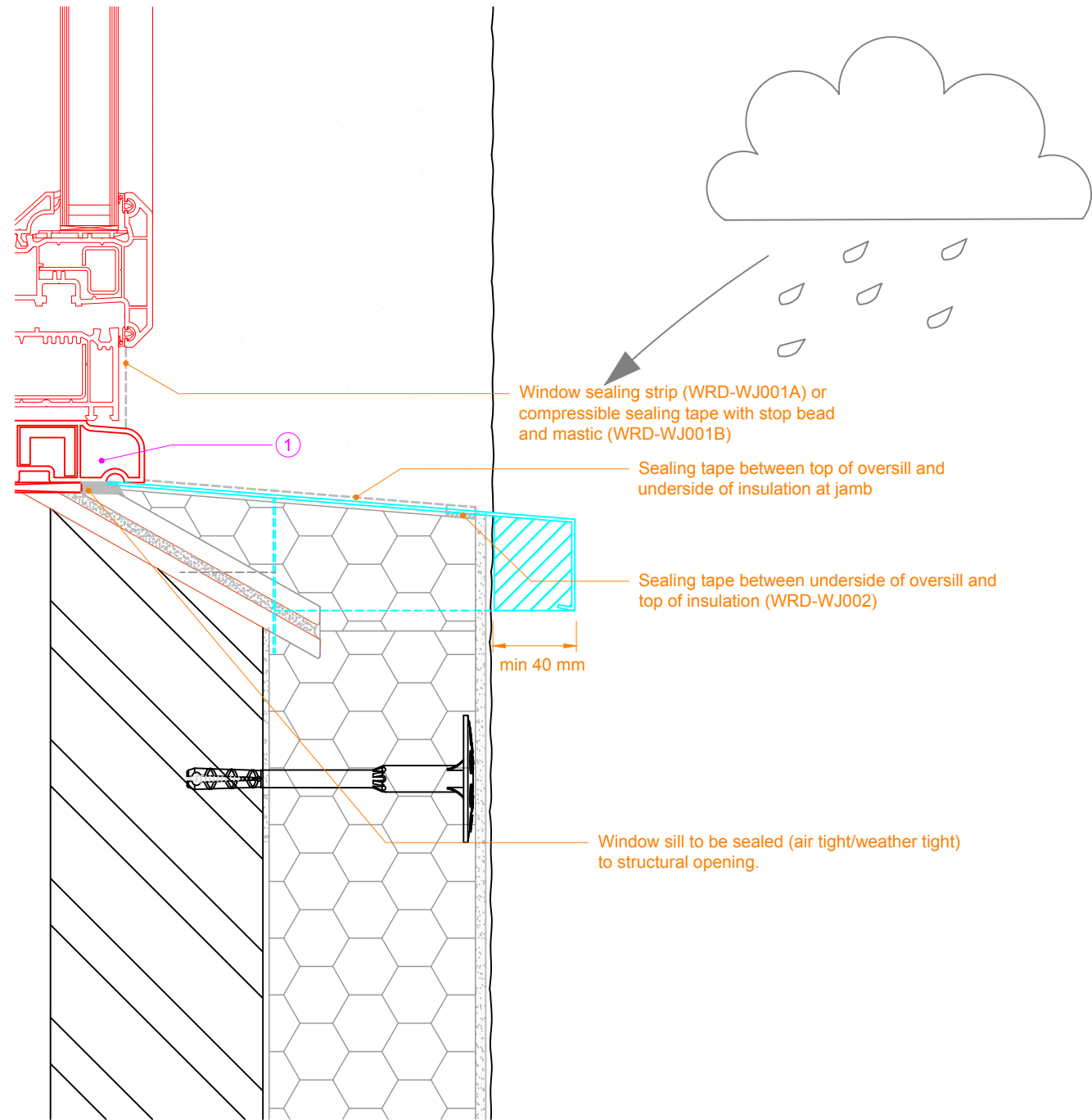

WEATHERING RISK

Risks:

- Window sill projection insufficient to provide effective water shedding.
- Differential thermal movement at render abutment to sill may allow water ingress.

Solutions:

- Windows sill and frame sealed against structural opening and weathertight prior to installation of the EWI system.
- EWI system sealed against window sill/oversill with fully compressed hydrophobic sealing tape and mastic sealant.
- Ensure that any existing drainage holes are not blocked, or install new drainage holes.
- Oversill to provide min 40 mm projection from face of render.*
- Designers should consider the use of sills with greater projection (50 mm) where exposure is Zone 4/very severe (BR262).

* See BSEN13914-1:2016 Design, preparation and application of external rendering and internal plastering. External rendering.

| | |
|----------|---|
| TITLE: | Existing Window with Tile Sill and Oversill |
| Dwg. No. | WRD-WS004 |
| Rev. | - |
| Date: | 18/12/2018 |

SPECIFICATION FOR WEATHERING AND THERMAL BRIDGE CONTROL

THERMAL BRIDGING RISK LEVEL

Note :

- All details indicate fixings that are thermally broken.



Green, no effect on risk level.

Captions :

- ① Insulation should have a thermal resistance of not less than 0.6 m²K/W. Common practice is to over sail the main insulation board past the reveal by 20 mm and adhesively fix the reveal insulation within the remaining recess.

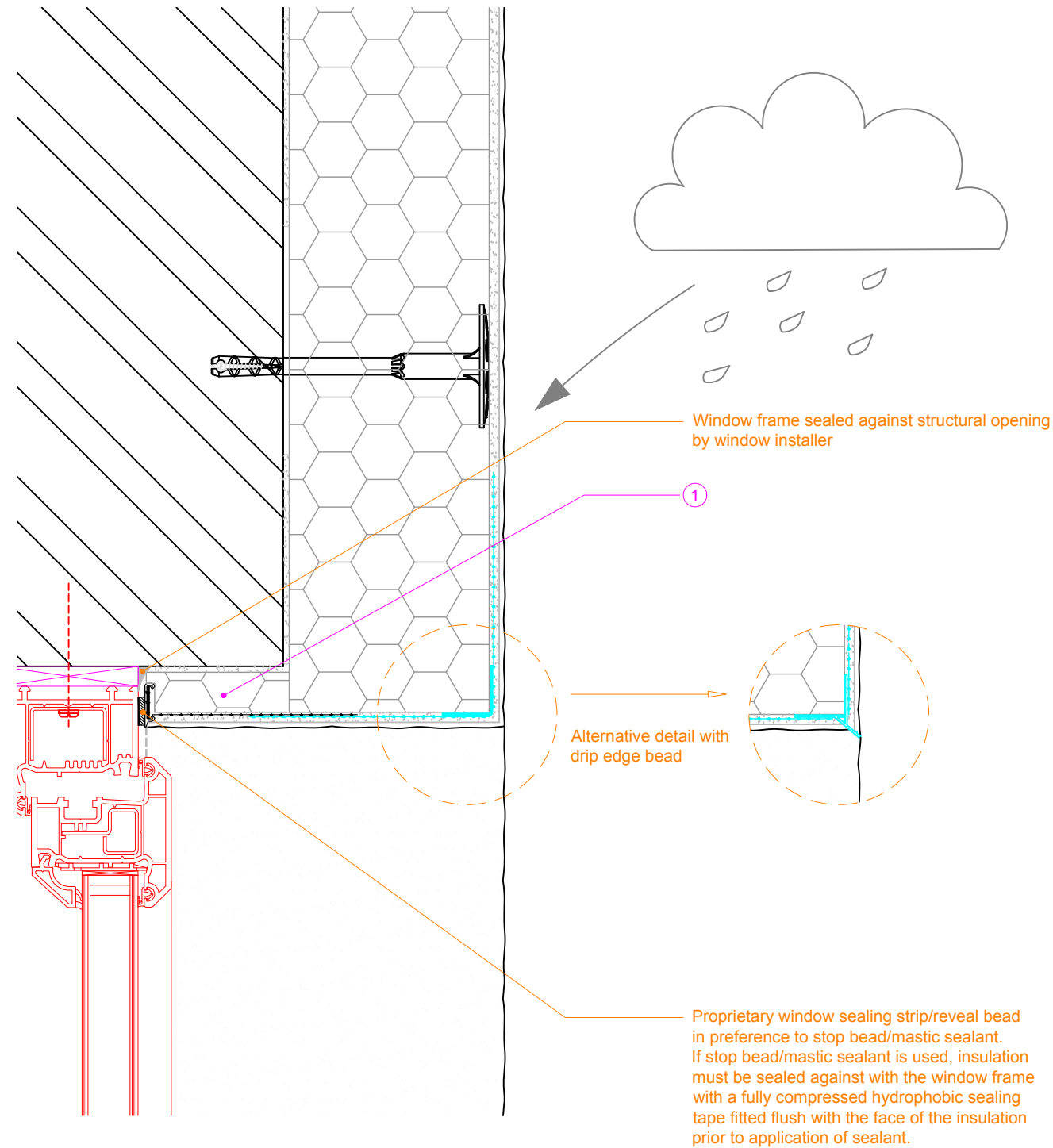

WEATHERING RISK

Risks: Water back-tracking to window frame.

Solutions:

- Windows frame sealed against structural opening and weathertight prior to installation of the EWI system.
- EWI system sealed against window frame at head using proprietary window sealing strip/reveals bead or sealing tape, stop bead and low-modulus sealant (see WRD-WJ001B).
- Drip edge corner bead at arris in lieu of standard corner bead to provide improved water shedding at render return into reveal at head.

| | |
|----------|-----------------------------|
| TITLE: | Insulation to Recessed Head |
| Dwg. No. | WRD-WH001 |
| Rev. | - |
| Date: | 18/12/2018 |

SPECIFICATION FOR WEATHERING AND THERMAL BRIDGE CONTROL

THERMAL BRIDGING RISK LEVEL

Note :

- All details indicate fixings that are thermally broken.



Green, no effect on risk level.

Captions :

- ① Ensure specified insulation is taken over the window frame by 15 - 20 mm.
- ② Window to be thermally broken frame.

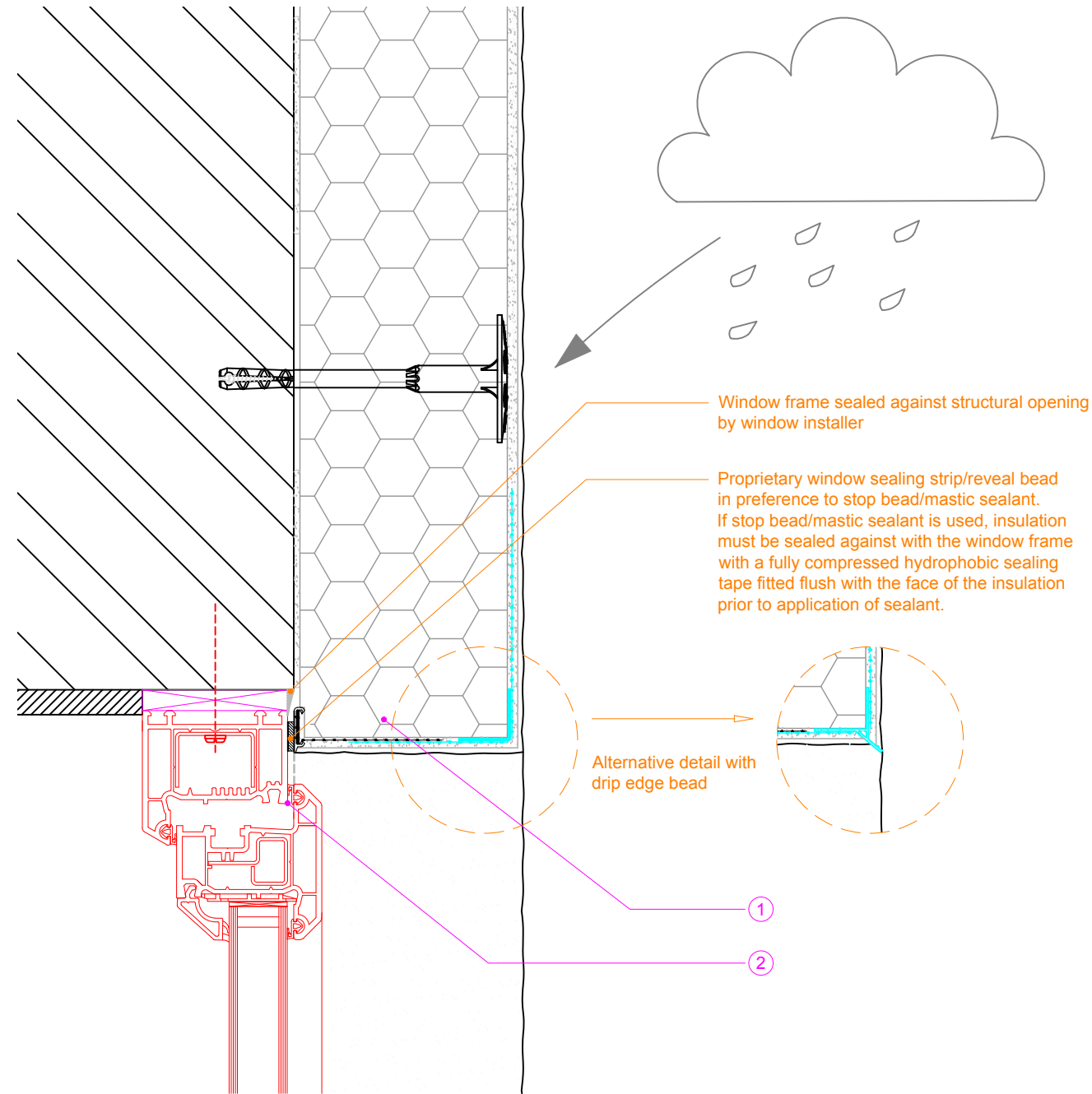

WEATHERING RISK

Risks: Water back-tracking to window frame.

Solutions:

- Windows frame sealed against structural opening and weathertight prior to installation of the EWI system.
- EWI system sealed against window frame at head using proprietary window sealing strip/reveals bead or sealing tape, stop bead and low-modulus sealant (see WRD-WJ001B).
- Drip edge corner bead at arris in lieu of standard corner bead to provide improved water shedding at render return into reveal at head.

| | |
|----------|----------------------------|
| TITLE: | Insulation over Flush Head |
| Dwg. No. | WRD-WH002 |
| Rev. | - |
| Date: | 18/12/2018 |

SPECIFICATION FOR WEATHERING AND THERMAL BRIDGE CONTROL

THERMAL BRIDGING RISK LEVEL

Note :

- All details indicate fixings that are thermally broken.



Amber if wall constructed in ≥ 225 mm solid brick. Not suitable for random stone constructions. Note that amber will increase the assessed inherent technical risk level in table B2 of PAS 2035 by 1.

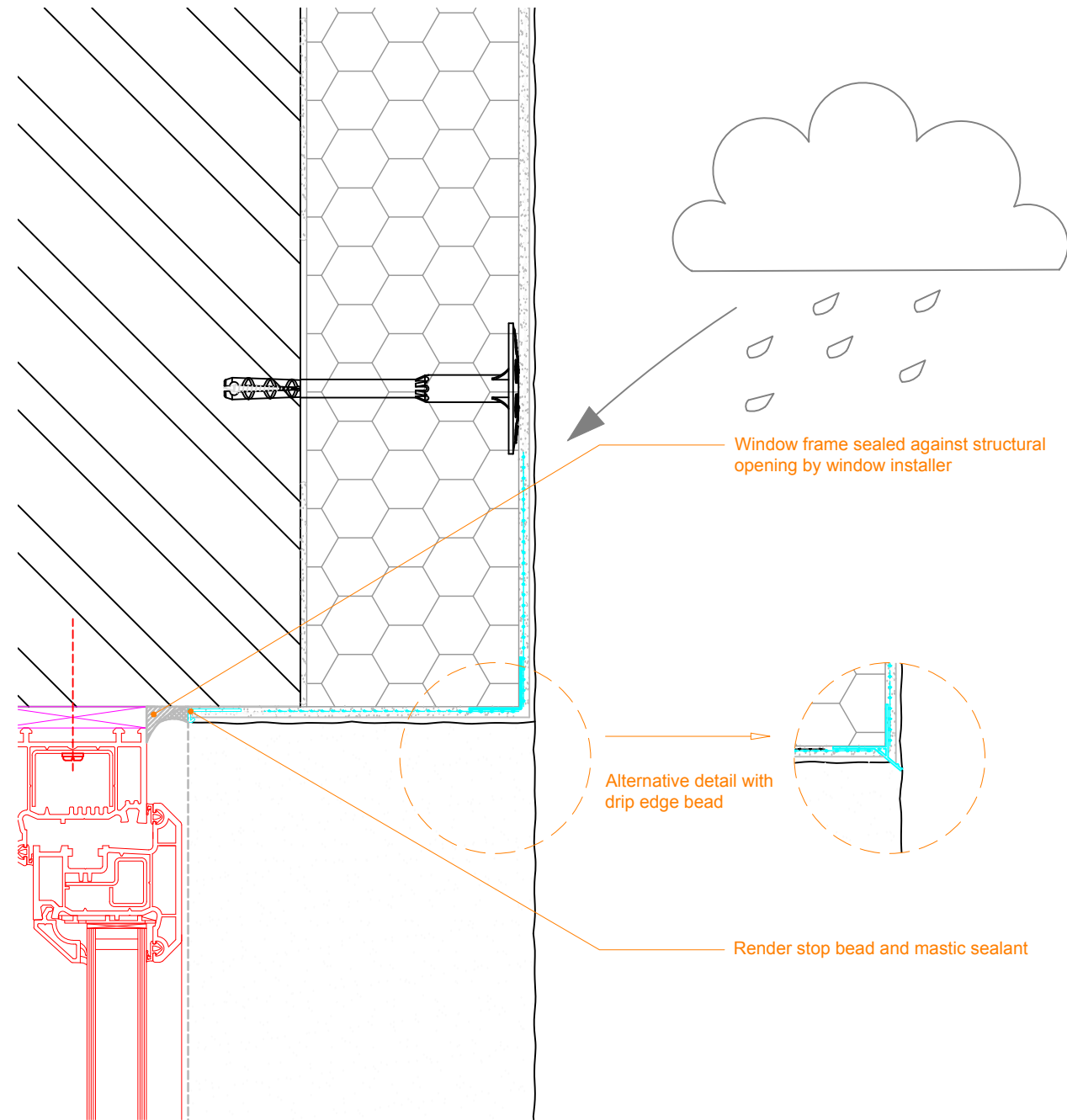

WEATHERING RISK

Risks: Water back-tracking to window frame.

Solutions:

- Windows frame sealed against structural opening and weathertight prior to installation of the EWI system.
- EWI system sealed against window frame at head using proprietary window sealing strip/reveals bead or sealing tape, stop bead and low-modulus sealant (see WRD-WJ001B).
- Drip edge corner bead at arris in lieu of standard corner bead to provide improved water shedding from render return into reveal at head.

| | |
|----------|-------------------|
| TITLE: | Un-Insulated Head |
| Dwg. No. | WRD-WH003 |
| Rev. | - |
| Date: | 18/12/2018 |

THERMAL BRIDGING RISK LEVEL

Note :

- All details indicate fixings that are thermally broken.



Amber. Note that amber will increase the assessed inherent technical risk level in table B2 of PAS 2035 by 1.

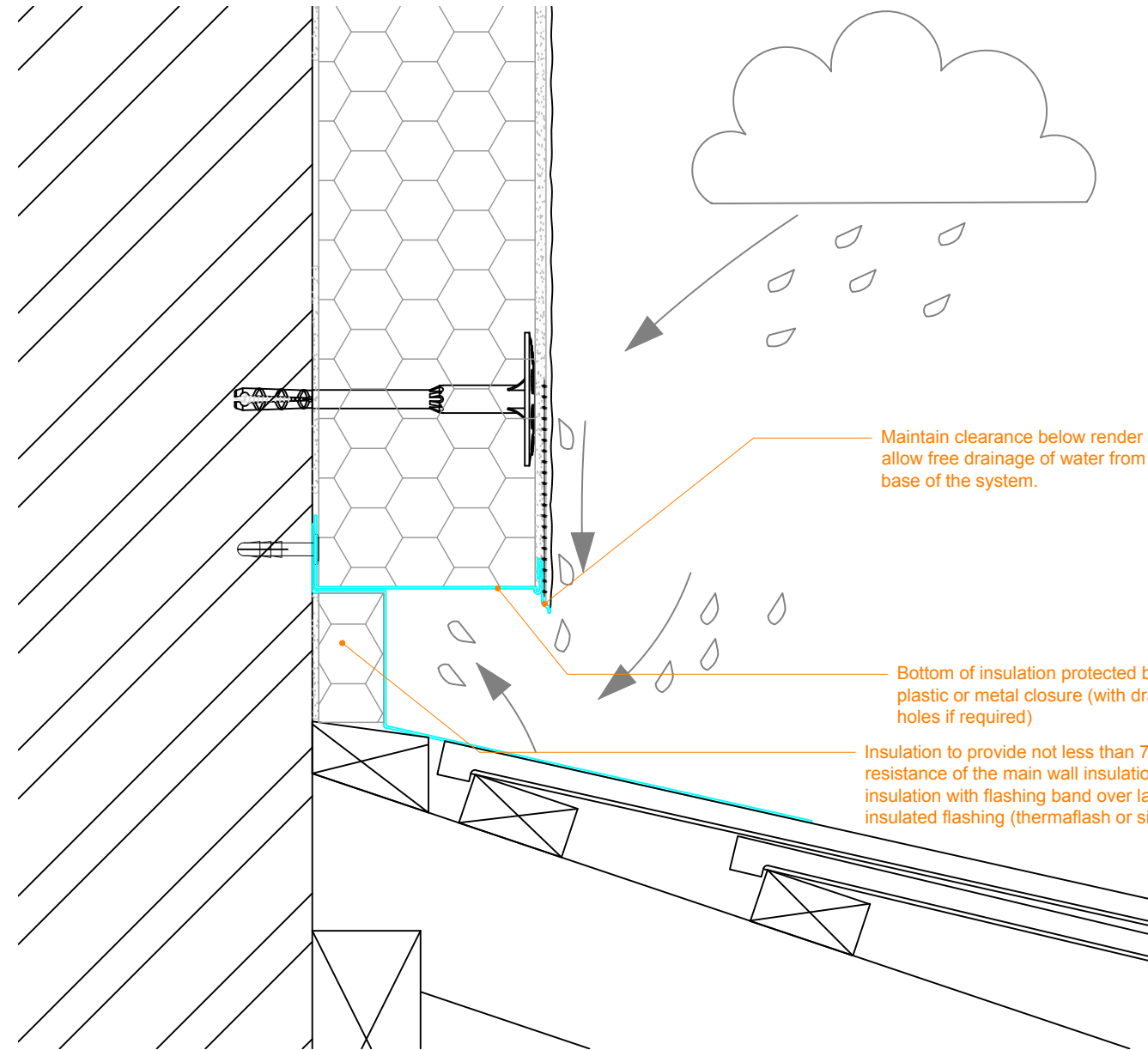

WEATHERING RISK

Risks: Inadequate free drainage of water from the bottom of the render prevents render surface from drying.

Solutions:

- Maintain a clear gap between the bottom edge of the render and the surface below. Bottom of the system protected by a plastic (low thermal conductivity) or metal starter track/base track.

| | |
|----------|-----------------------|
| TITLE: | Pitched Roof Abutment |
| Dwg. No. | WRD-RA001 |
| Rev. | - |
| Date: | 18/12/2018 |

THERMAL BRIDGING RISK LEVEL

Note :

- All details indicate fixings that are thermally broken.



Amber. Note that amber will increase the assessed inherent technical risk level in table B2 of PAS 2035 by 1.

WEATHERING RISK

Risks: Inadequate free drainage of water from the bottom of the render prevents render surface from drying.

Solutions:

- Maintain a clear gap between the bottom edge of the render and the surface below. Bottom of the system protected by a plastic (low thermal conductivity) or metal starter track/base track.

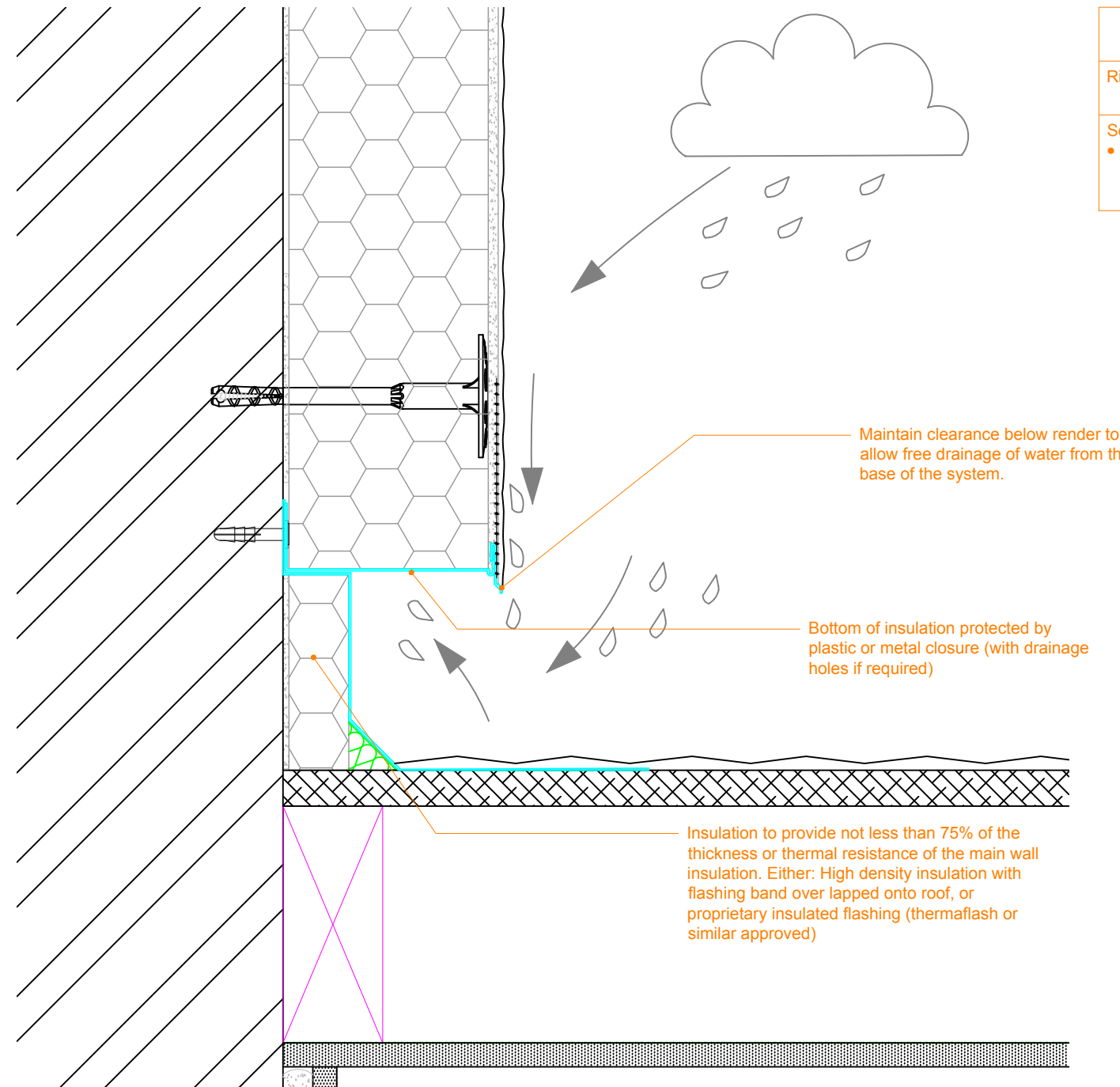

| | |
|----------|--------------------|
| TITLE: | Flat Roof Abutment |
| Dwg. No. | WRD-RA002 |
| Rev. | - |
| Date: | 18/12/2018 |

THERMAL BRIDGING RISK LEVEL

Note :

- All details indicate fixings that are thermally broken.



Green, no effect on risk level.

Captions :

- ① Ensure loft insulation extends across top of external wall insulation.
- ② System installed to underside of existing soffit and fascia or, if practicable, remove existing fascia and install system as far up the existing wall as possible

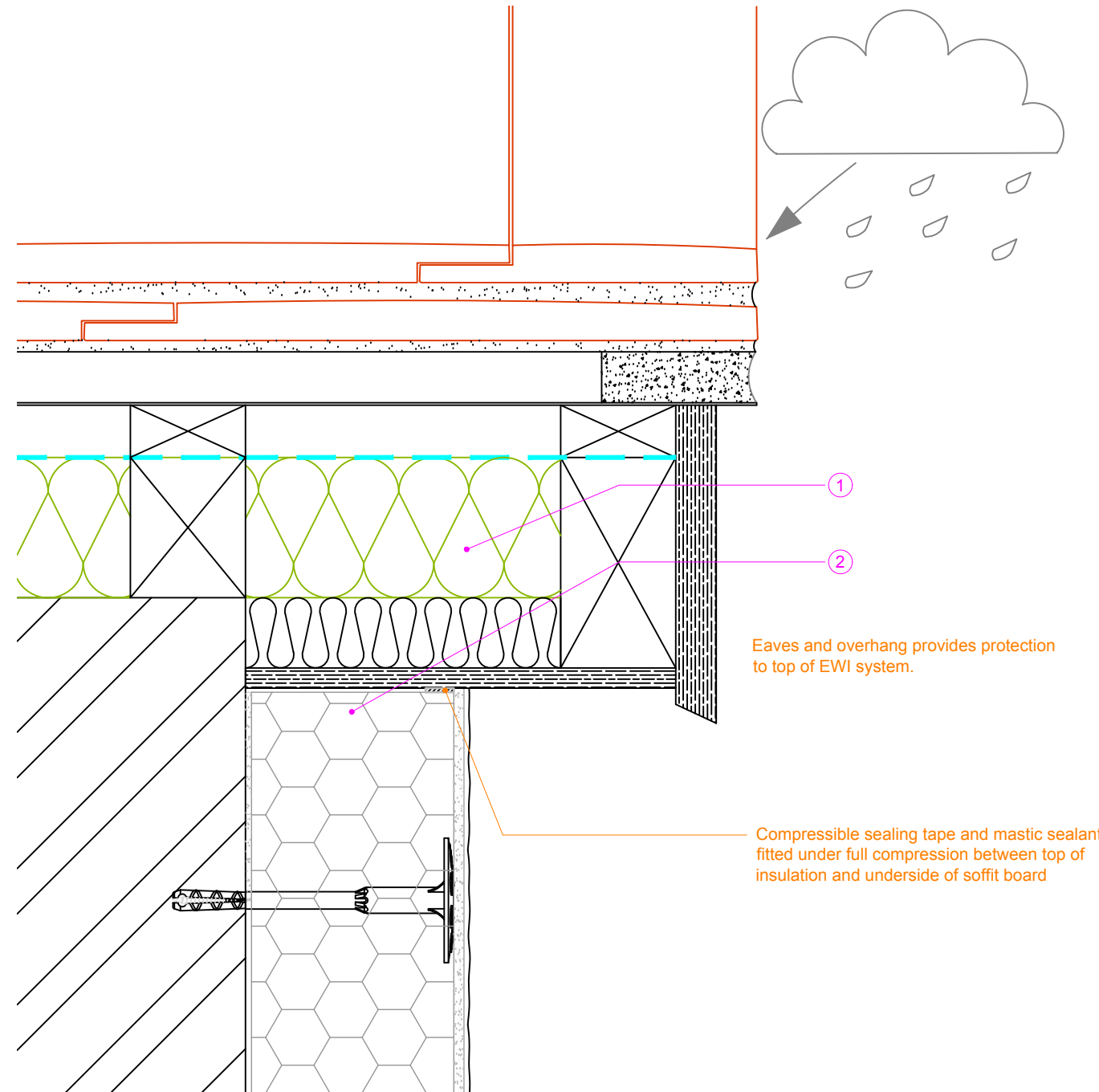

WEATHERING RISK

Risks: Low. Overhanging verge provides weathering protection to EWI system. Larger overhang offers greater protection.

Solutions: Roof extended as necessary to provide overhang to EWI system.

| | |
|----------|----------------------------|
| TITLE: | Extended/Overhanging Verge |
| Dwg. No. | WRD-V002 |
| Rev. | - |
| Date: | 18/12/2018 |

THERMAL BRIDGING RISK LEVEL

Note :

- All details indicate fixings that are thermally broken.



Green, no effect on risk level.

Captions :

- 1 Ensure ventilation pathway is maintained: It is critical that cross-flow ventilation is maintained.
- 2 Existing soffit board removed and system taken up entire wall to ensure continuity with loft insulation.
- 3 Loft insulation must extend across top of wall and across top of external wall insulation.

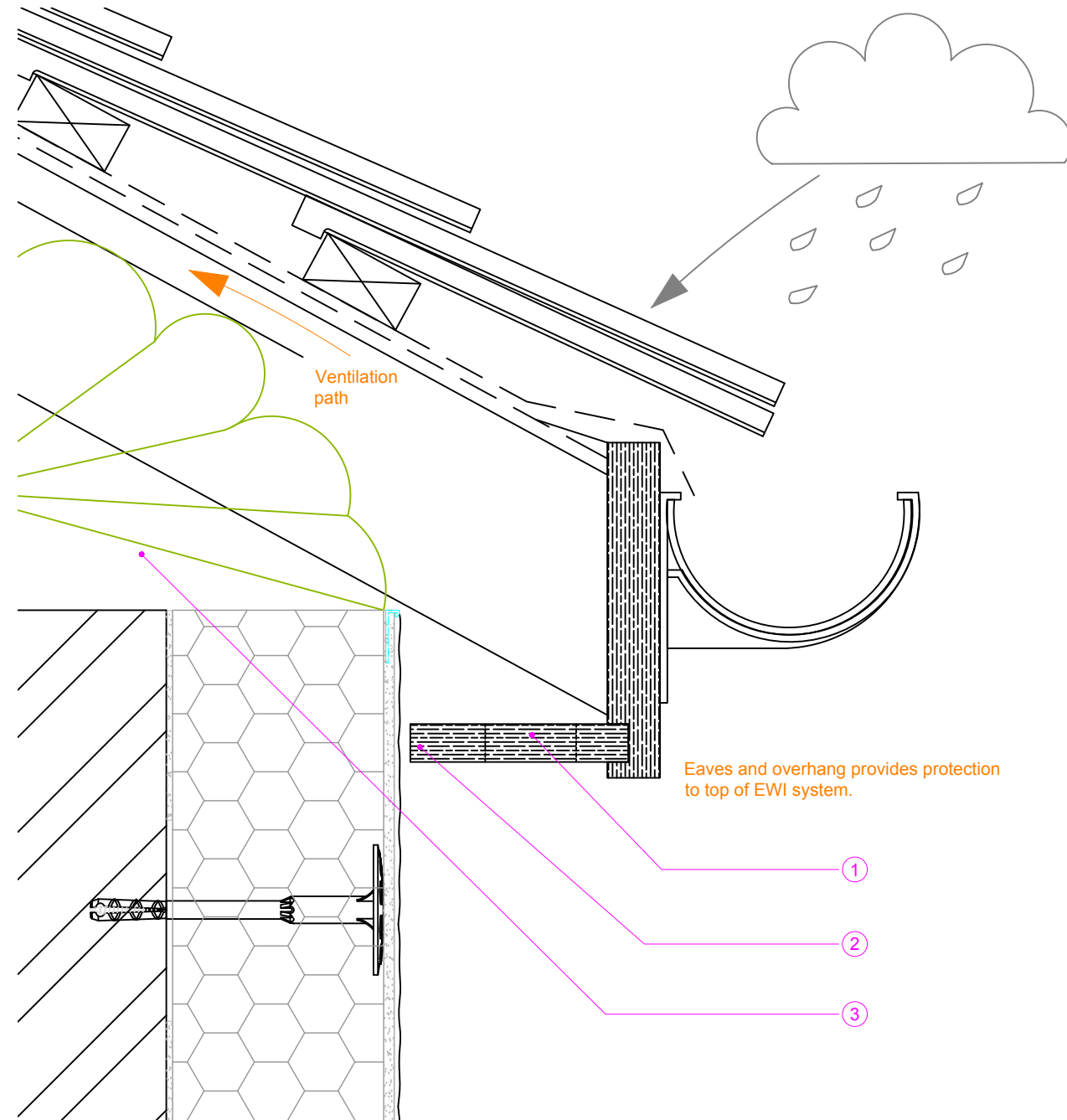

WEATHERING RISK

Risks: Low. EWI system protected by roof overhang at eaves.

Solutions: N/A

| | |
|----------|--------------------------------|
| TITLE: | Extended/Overhanging Eaves (1) |
| Dwg. No. | WRD-E001 |
| Rev. | - |
| Date: | 18/12/2018 |

SPECIFICATION FOR WEATHERING AND THERMAL BRIDGE CONTROL

THERMAL BRIDGING RISK LEVEL

Note :

- All details indicate fixings that are thermally broken.



Green if ceiling height lower than top of EWI system.



Amber if ceiling height above top of EWI system. Note that amber will increase the assessed inherent technical risk level in table B2 of PAS 2035 by 1.

Captions :

- ① Ensure ventilation pathway is maintained: It is critical that cross-flow ventilation is maintained.
- ② Loft insulation must extend across top of wall and across top of external wall insulation.

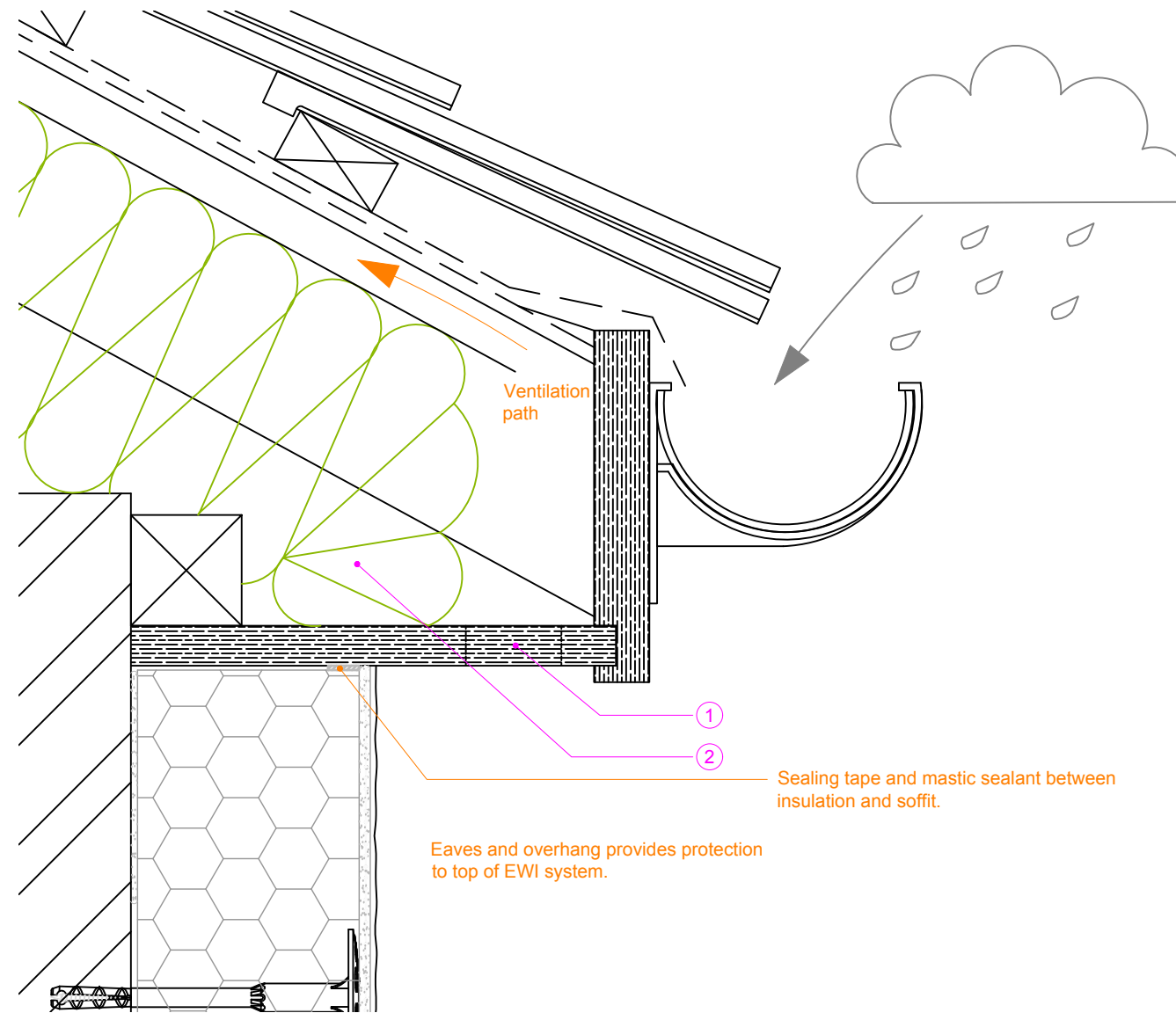

WEATHERING RISK

Risks: Low. EWI system protected by roof overhang at eaves.

Solutions: N/A

| | |
|----------|--------------------------------|
| TITLE: | Extended/Overhanging Eaves (2) |
| Dwg. No. | WRD-E002 |
| Rev. | - |
| Date: | 18/12/2018 |

THERMAL BRIDGING RISK LEVEL

Note :

- All details indicate fixings that are thermally broken.



Green, no effect on risk level.

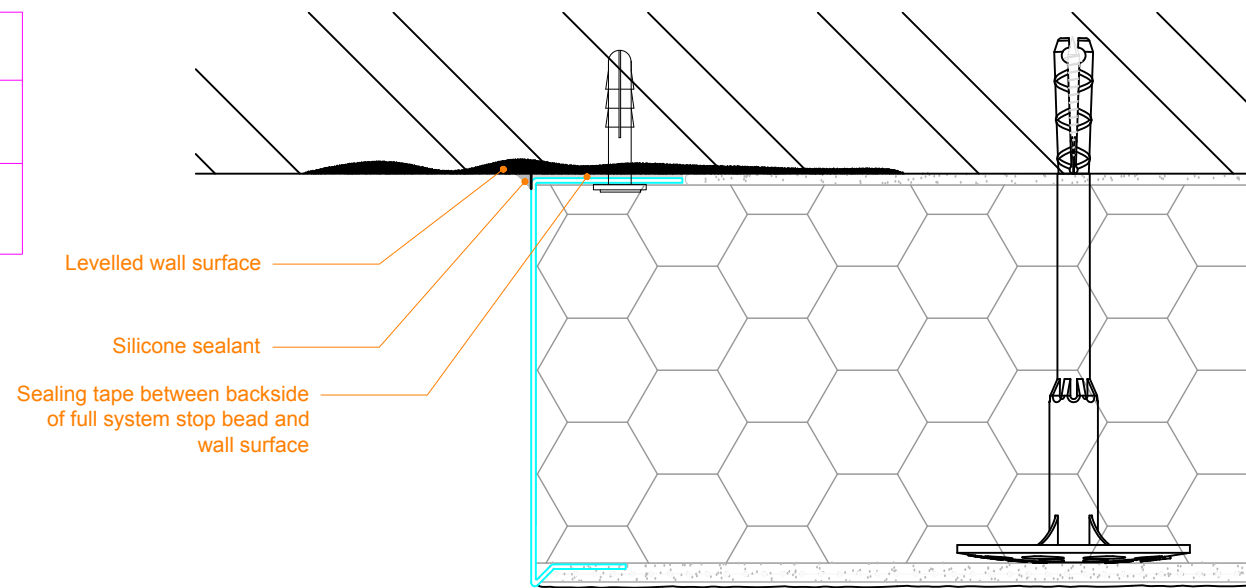

Plan Section

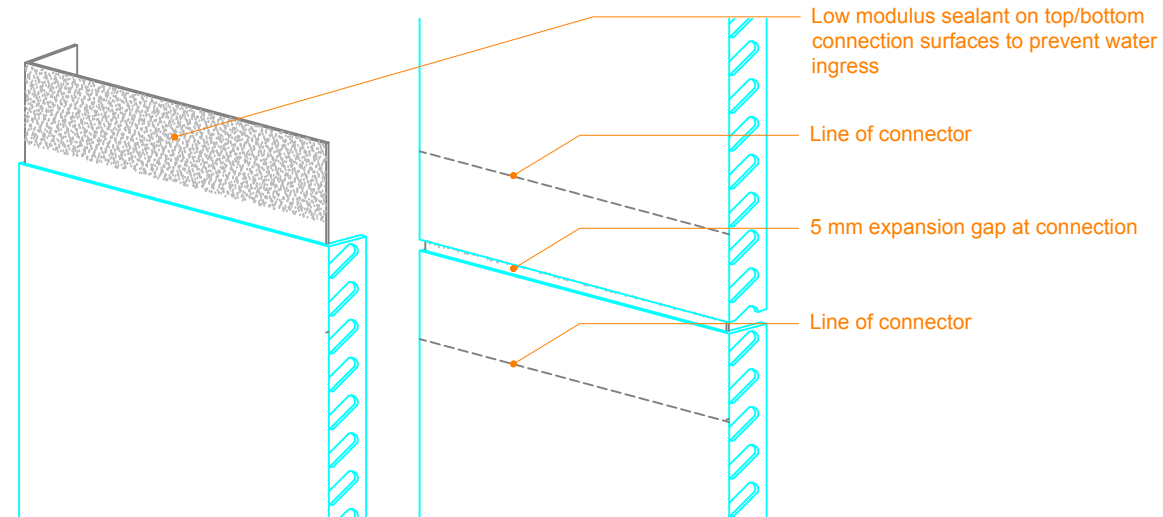

Isometric - Connector Detail

WEATHERING RISK

Risks:

- Inadequate seal between full system stop bead and wall surface allows water penetration behind EWI system.
- Adjoining sections of full system stop bead inadequately sealed: water ingress occurs.

Solutions:

- Surface against which full system stop bead is attached shall be filled/levelled to provide a flat surface against which a weathertight seal can be made.
- Full system stop bead sealed against wall face.
- Adjacent sections of full system stop bead joined together with metal connectors with seals both side of joint.

| | |
|----------|--|
| Title: | EWI Termination - with Full System Stop Bead |
| Dwg. No. | WRD-T001 |
| Rev. | - |
| Date: | 18/12/2018 |

SPECIFICATION FOR WEATHERING AND THERMAL BRIDGE CONTROL

THERMAL BRIDGING RISK LEVEL

Note :

- All details indicate fixings that are thermally broken.
- Movement of service boxes should be undertaken by the owner of the box, i.e. The utility company, or movement without consent would be an act of trespass.

 Green, no effect on risk level.

Captions :

- ① Remove service box and re-position on the out side face of the EWI system using thermally broken supports/fixings.

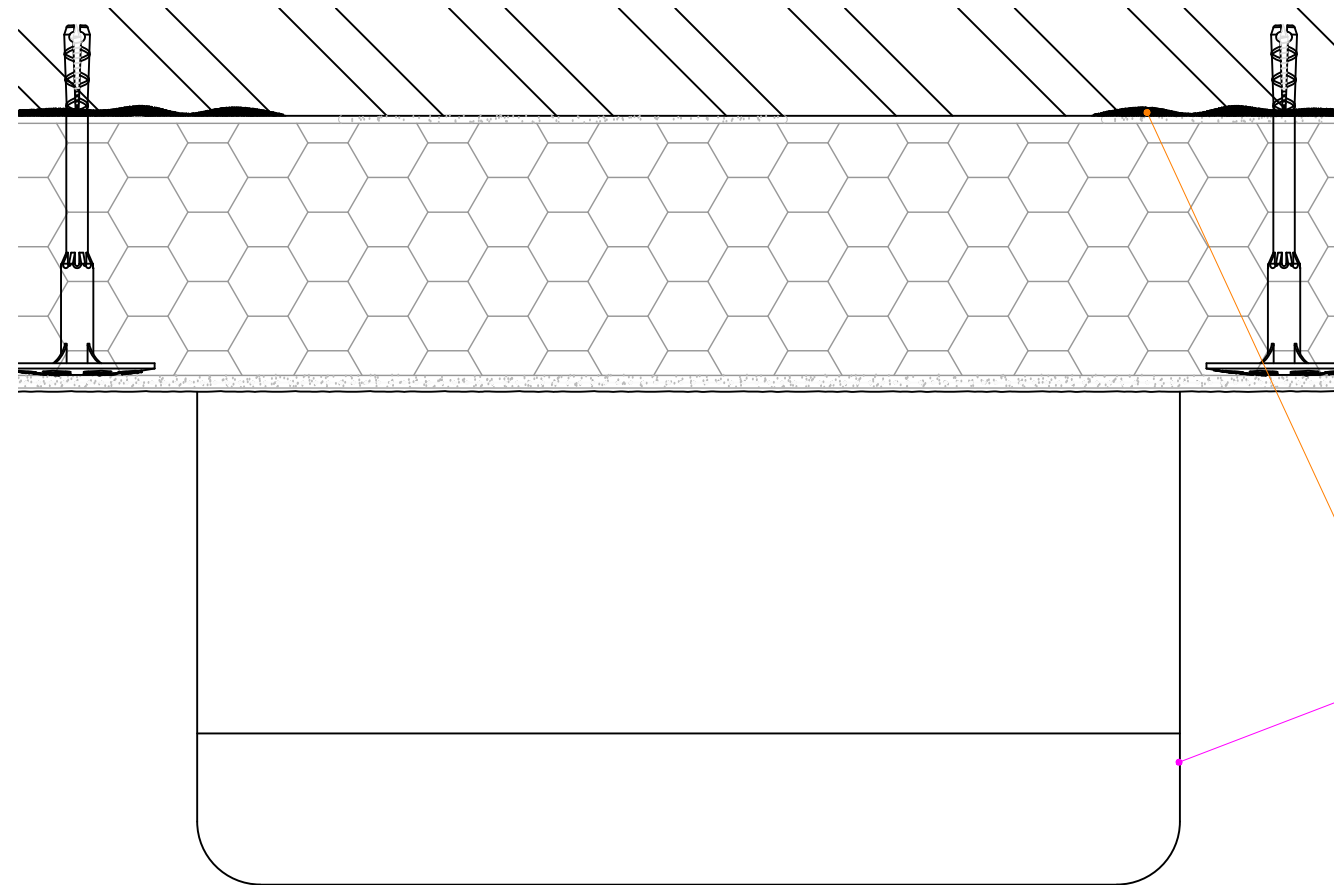

WEATHERING RISK

Risks: N/A

Solutions: N/A

Plan Section - Service Box Outside of EWI System

THERMAL BRIDGING RISK LEVEL

Note :

- All details indicate fixings that are thermally broken.
- Movement of service boxes should be undertaken by the owner of the box, i.e. The utility company, or movement without consent would be an act of trespass.

 Amber. Note that amber will increase the assessed inherent technical risk level in table B2 of PAS 2035 by 1.

Captions :

- ② Provide external grade cavity closer with thermal resistance $\geq 75\%$ of wall insulation.
- ③ For gap to sides/edges of box refer to 'Specification for the installation of external wall insulation ensuring safety and operation of fuel burning appliances V.1.0 31st March 2017'. Surface mounted gas meter boxes require a min. gap of 25 mm for access and maintenance.

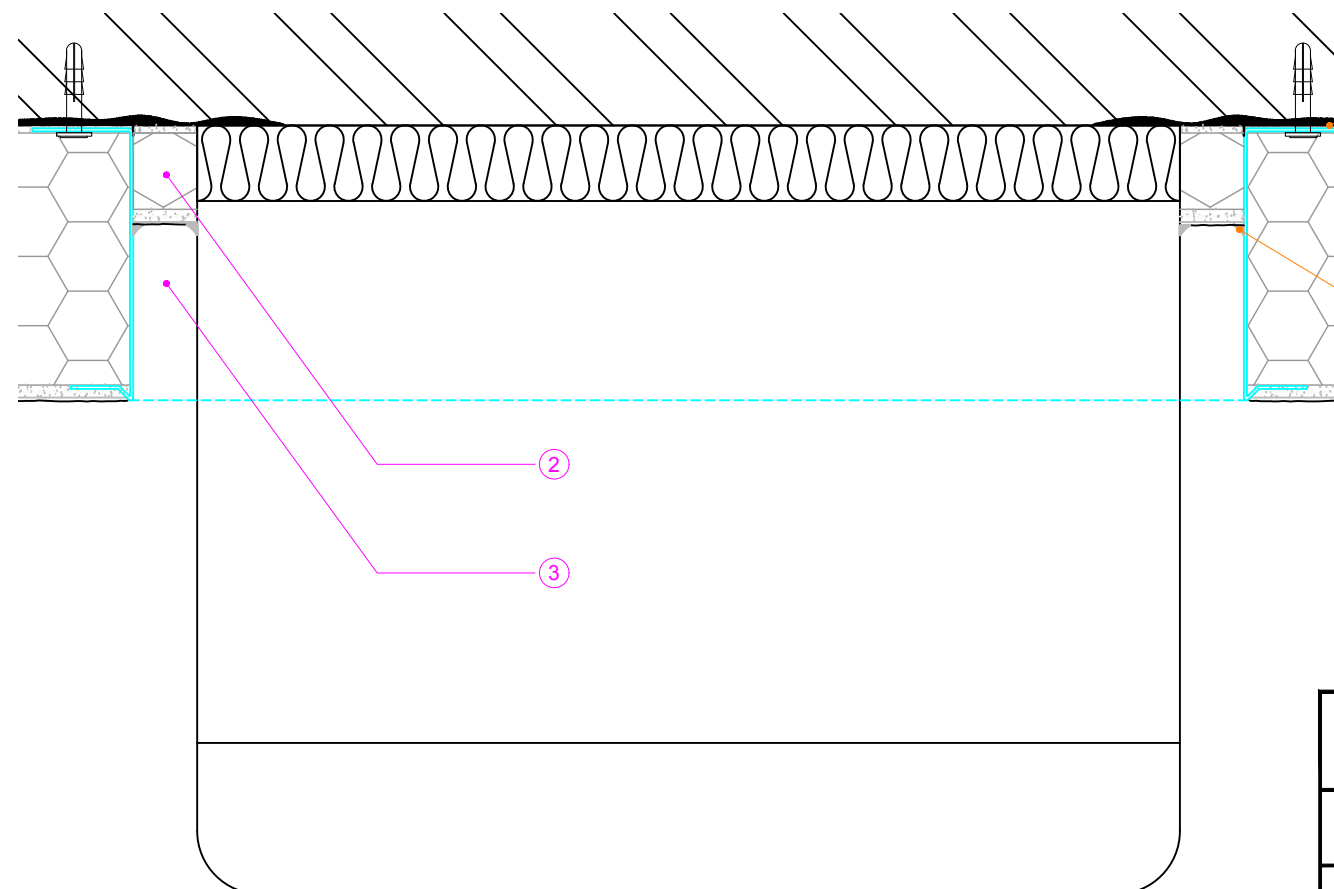

Plan Section - Thin Board Insulation behind Service Box

| | |
|----------|-----------------------------|
| Title: | Service Box - Removable Box |
| Dwg. No. | WRD-SB001 |
| Rev. | - |
| Date: | 18/12/2018 |

SPECIFICATION FOR WEATHERING AND THERMAL BRIDGE CONTROL

THERMAL BRIDGING RISK LEVEL

Note :

- All details indicate fixings that are thermally broken.
- Movement of service boxes should be undertaken by the owner of the box, i.e. The utility company, or movement without consent would be an act of trespass.



Green, no effect on risk level.

Captions :

- ① Remove service box and re-position on the out side face of the EWI system using thermally broken supports/fixings.

WEATHERING RISK

Risks: N/A

Solutions: N/A

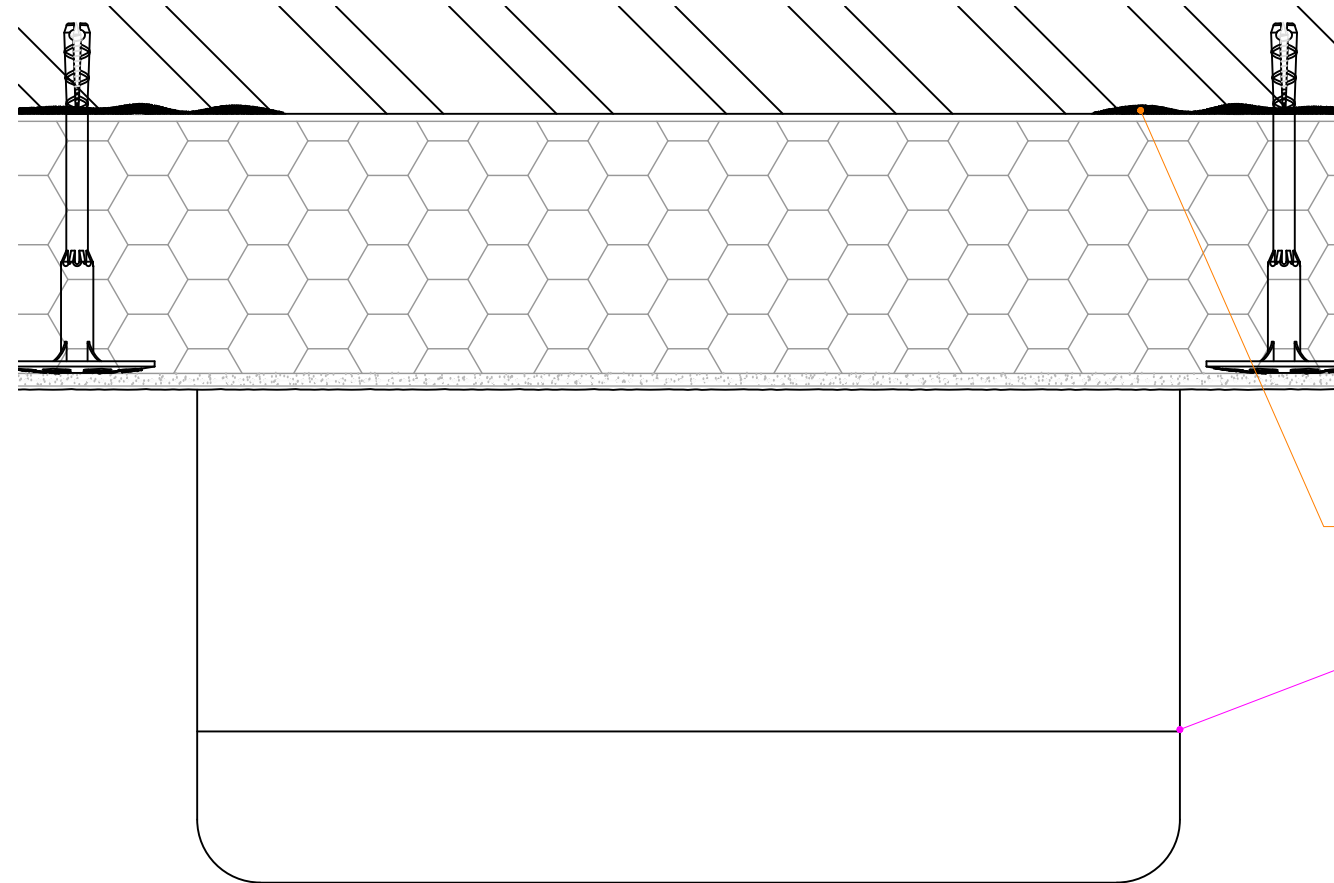

Plan Section - Service Box Outside of EWI System

THERMAL BRIDGING RISK LEVEL

Note :

- All details indicate fixings that are thermally broken.
- Movement of service boxes should be undertaken by the owner of the box, i.e. The utility company, or movement without consent would be an act of trespass.



Amber. Note that amber will increase the assessed inherent technical risk level in table B2 of PAS 2035 by 1.

Captions :

- ② Provide insulation within service box where practicable/missible.

Refer to 'Specification for the installation of external wall insulation ensuring safety and operation of fuel burning appliances V.1.0 31st March 2017'.

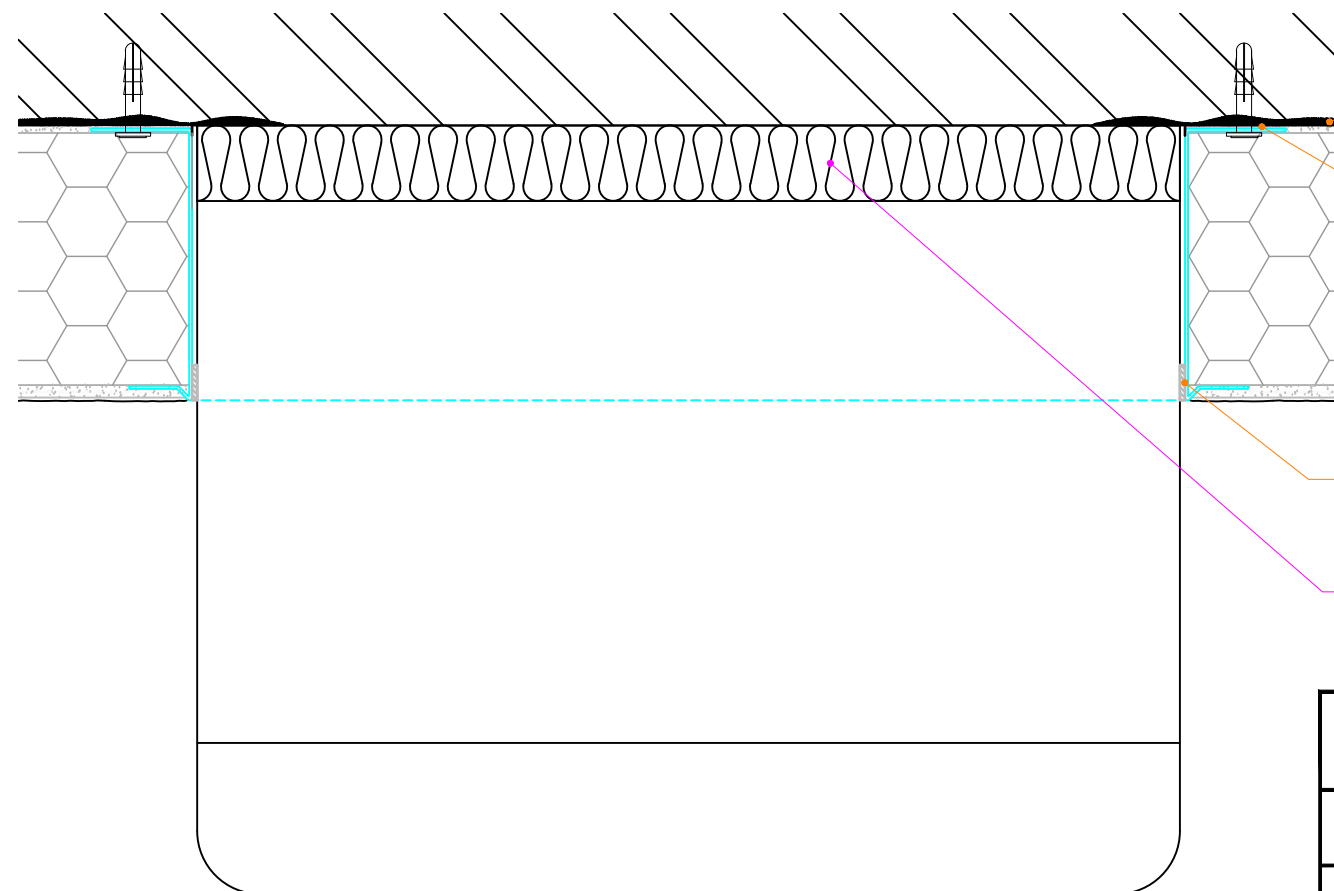

Plan Section - Thin Board Insulation behind Service Box

| | |
|----------|----------------------------|
| Title: | Service Box - Front Access |
| Dwg. No. | WRD-SB002 |
| Rev. | - |
| Date: | 18/12/2018 |

SPECIFICATION FOR WEATHERING AND THERMAL BRIDGE CONTROL

THERMAL BRIDGING RISK LEVEL

Note :

- All details indicate fixings that are thermally broken.



Green, no effect on risk level.

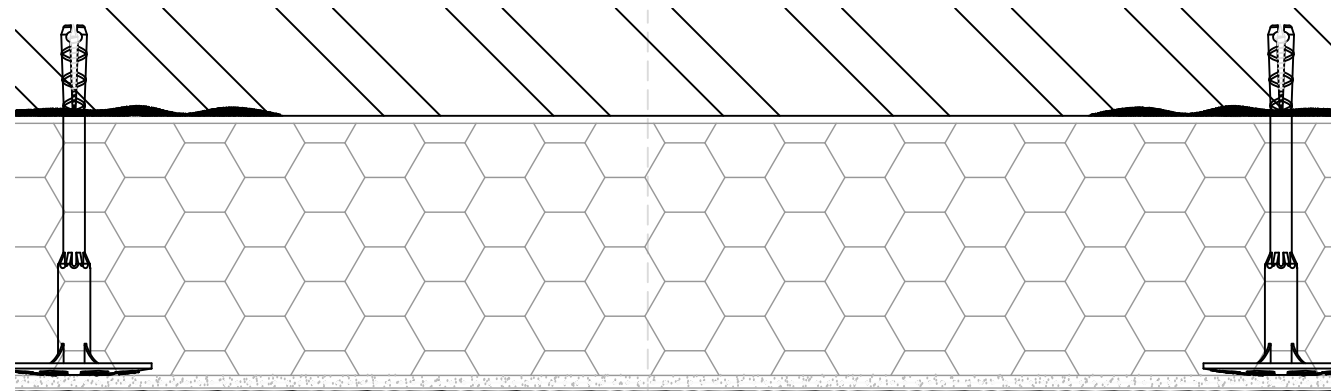

Cable or pipe removed and repositioned forward of the EWI system

WEATHERING RISK

Risks: N/A

Solutions: N/A

Plan Section - External Pipe/Cable

THERMAL BRIDGING RISK LEVEL

Note :

- All details indicate fixings that are thermally broken.



Amber. Note that amber will increase the assessed inherent technical risk level in table B2 of PAS 2035 by 1.

Captions :

- 1 Provide insulation within gas pipe/electrical services enclosure where practicable/permissible.

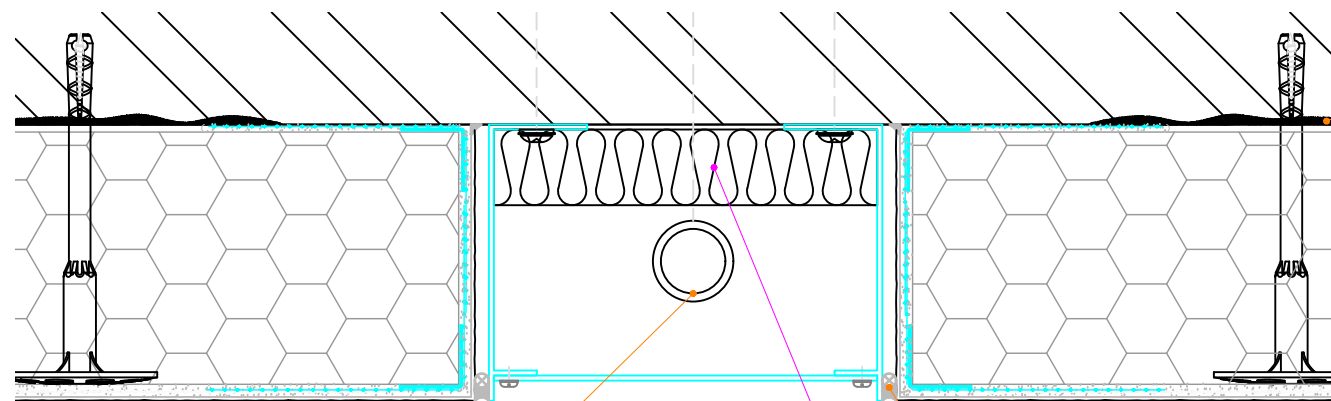

Levelled wall surface

Retained cable or pipe

Service enclosure to be sealed against EWI system with backing rod and mastic seal. For gas pipes, enclosures must have removable ventilated covers in accordance with the 'Specification for the installation of external wall insulation ensuring safety and operation of fuel burning appliances V.1.0 31st March 2017'. Ensure that the EWI system is fully sealed to the wall to prevent gas entry into the system.

Plan Section - Thin Board Insulation behind Gas/Electrical Service Enclosure

| | |
|----------|------------------------------|
| Title: | Gas Pipe / Electrical Cables |
| Dwg. No. | WRD-G001 |
| Rev. | - |
| Date: | 18/12/2018 |

SPECIFICATION FOR WEATHERING AND THERMAL BRIDGE CONTROL

THERMAL BRIDGING RISK LEVEL

Note :

- All details indicate fixings that are thermally broken.



Green, no effect on risk level.

Captions :

- ① Thermally broken, cantilevered through fixing. Refer to manufacturer for allowable loadings.

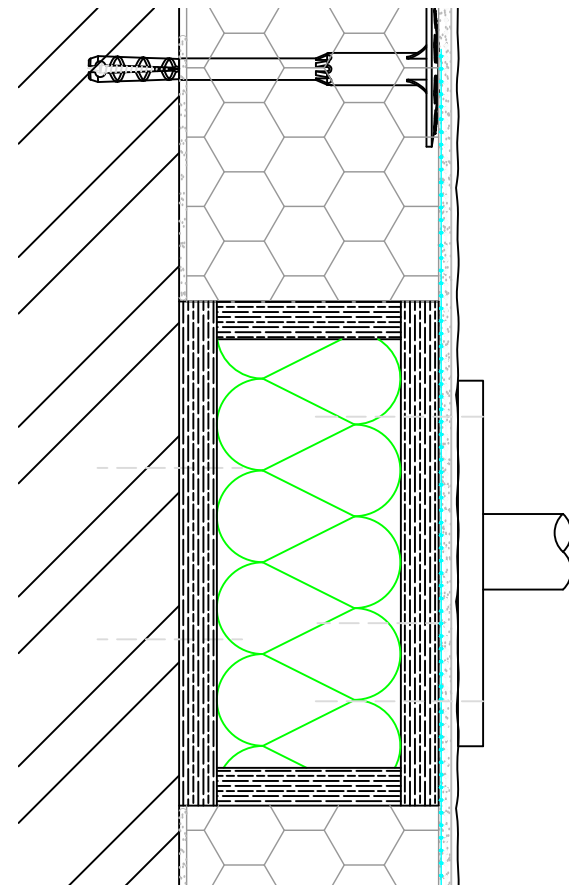

Insulated Box Pattern

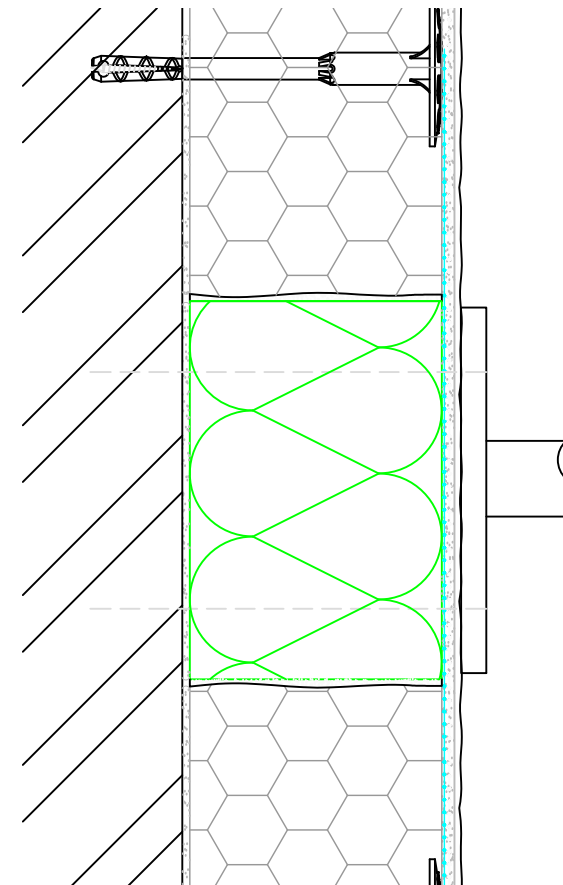

HD Insulation Block

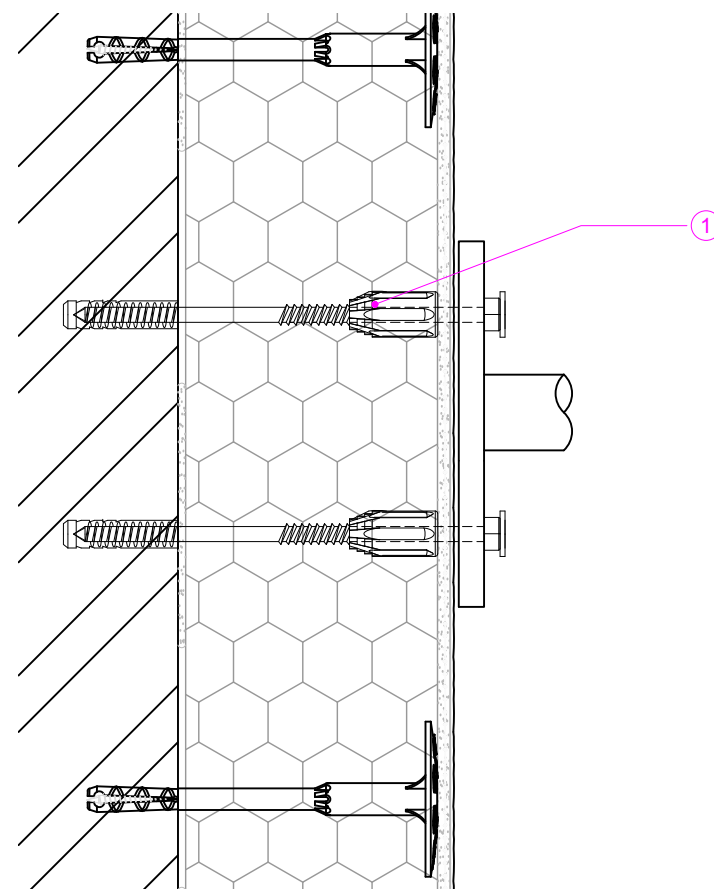

Thermal Broken Fixing

WEATHERING RISK

Risks: Water ingress into insulation at fixings.

Solutions:

- Ensure fixings are sealed against render with EPDM gaskets or proprietary waterproof sealant.

| | |
|----------|-------------------------------|
| Title: | Heavy Weight External Fixture |
| Dwg. No. | WRD-EFF001 |
| Rev. | - |
| Date: | 18/12/2018 |

SPECIFICATION FOR WEATHERING AND THERMAL BRIDGE CONTROL

THERMAL BRIDGING RISK LEVEL

Note :

- All details indicate fixings that are thermally broken.



Green, no effect on risk level.

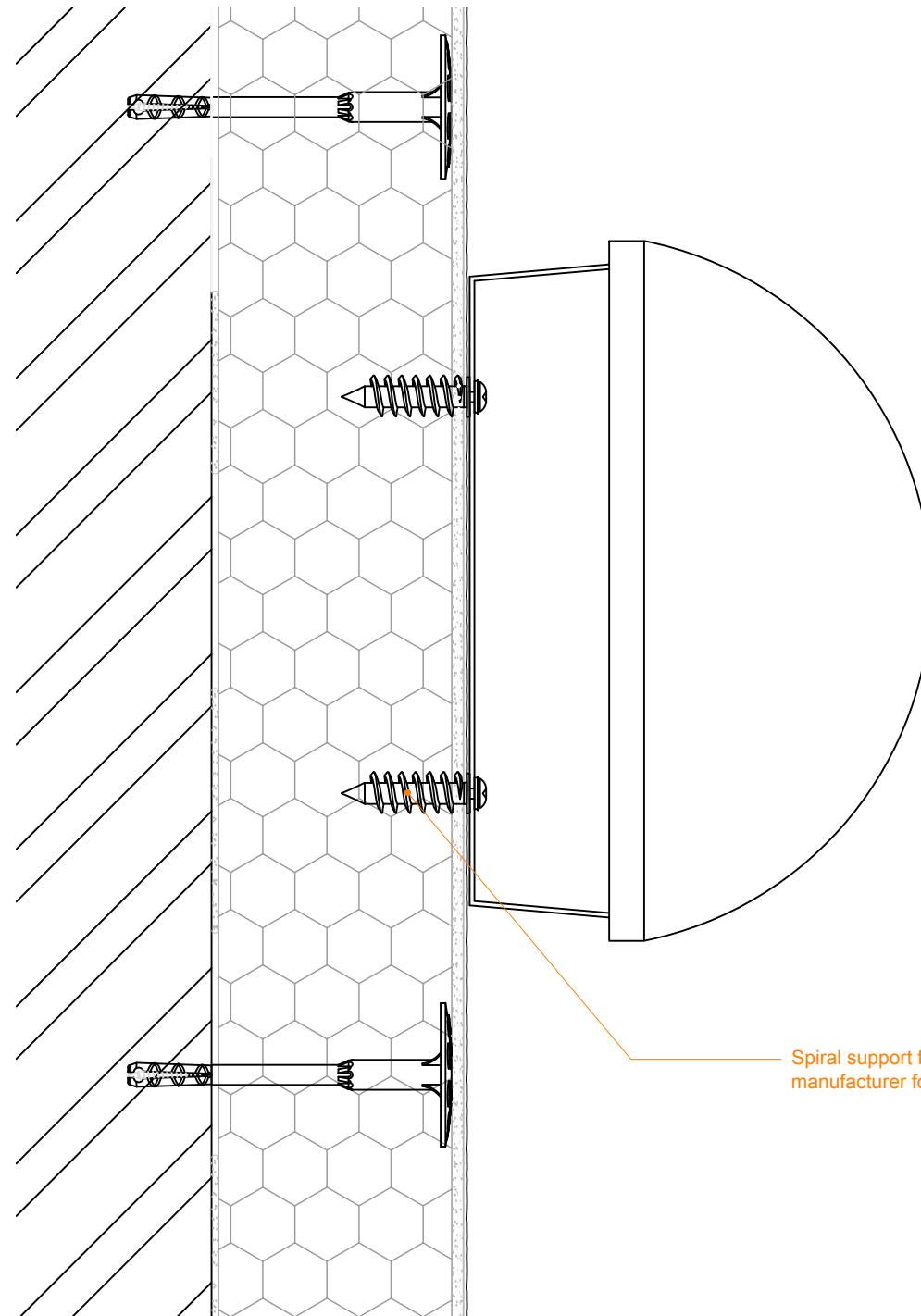

WEATHERING RISK

Risks: Water ingress into insulation at fixings.

Solutions:

- Ensure fixings are sealed against render with EPDM gaskets or proprietary waterproof sealant.

| | |
|----------|-------------------------------|
| Title: | Light Weight External Fixture |
| Dwg. No. | WRD-EFF002 |
| Rev. | - |
| Date: | 18/12/2018 |

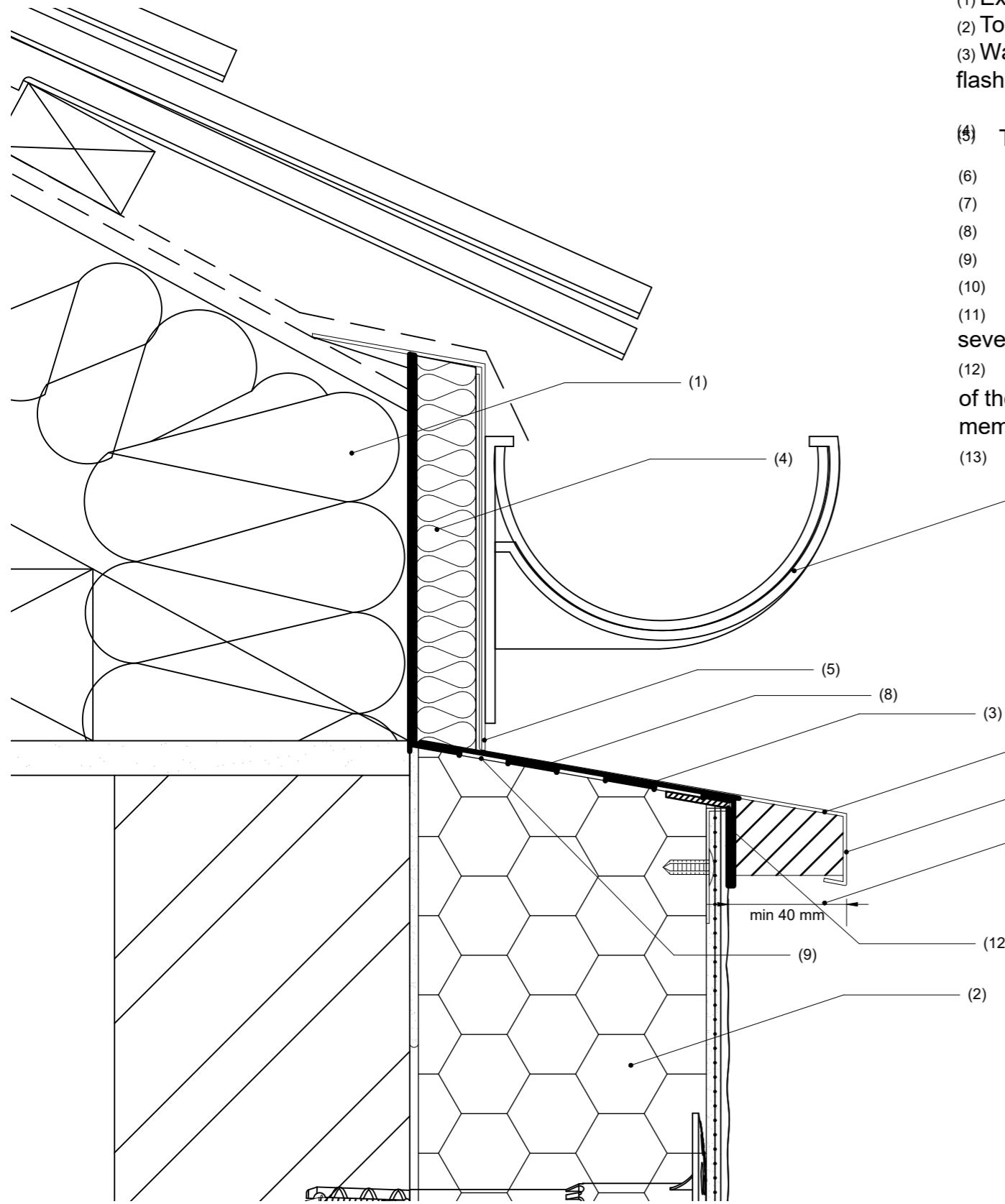

- (1) Existing fascia & gutter removed. Insulation packed between rafter feet;
- (2) Top of insulation board chamfered to form min. 10 degree fall;
- (3) Waterproof membrane with minimum 100 mm laps at all joints. Joints offset (min 100 mm) from joints in metal flashing. Membrane to have positive fall away from roof;
- (4) Thermal insulation (min. 0.6 m² K/W), **See Notes Below.**
- (5) Metal flashing (single- or 2-part) with min. 10 degree fall;
- (6) Face width of flashing min. 40 mm;
- (7) Gutter to be fixed through insulated flashing to substrate;
- (8) Membrane bonded to top of EWI system.
- (9) No seal between underside of metal flashing and top of membrane (maintain water egress pathway);
- (10) Minimum 40 mm between drip edge of metal flashing and face of render. Increase to min. 50 mm in severe/very severe exposure locations;
- (11) Adjacent sections of metal trims incorporate over- or under-connections with min. 40 mm projection on each side of the joint. Expansion gap of 2-3mm between aluminium lengths. Joints between flashings offset from joints between membranes by min 100 mm
- (12) Membrane to be sealed to the render system below

Note A: Felt to be pressed and adhesively fixed.
 Note B: Ventilation zone should be at least 25mm and should be continuous up to the Apex, in line with BS EN 5250 guidance Note C: Insulation types to achieve 0.6W/mk are; 20mm EPS at 0.031 = 0.645, 30mm XPS at 0.035 = 0.857

Title : FLUSH EAVES - INSULATED FLASHING WITH EXTERNAL-SEPARATE GUTTER

RCS Detail 1 :

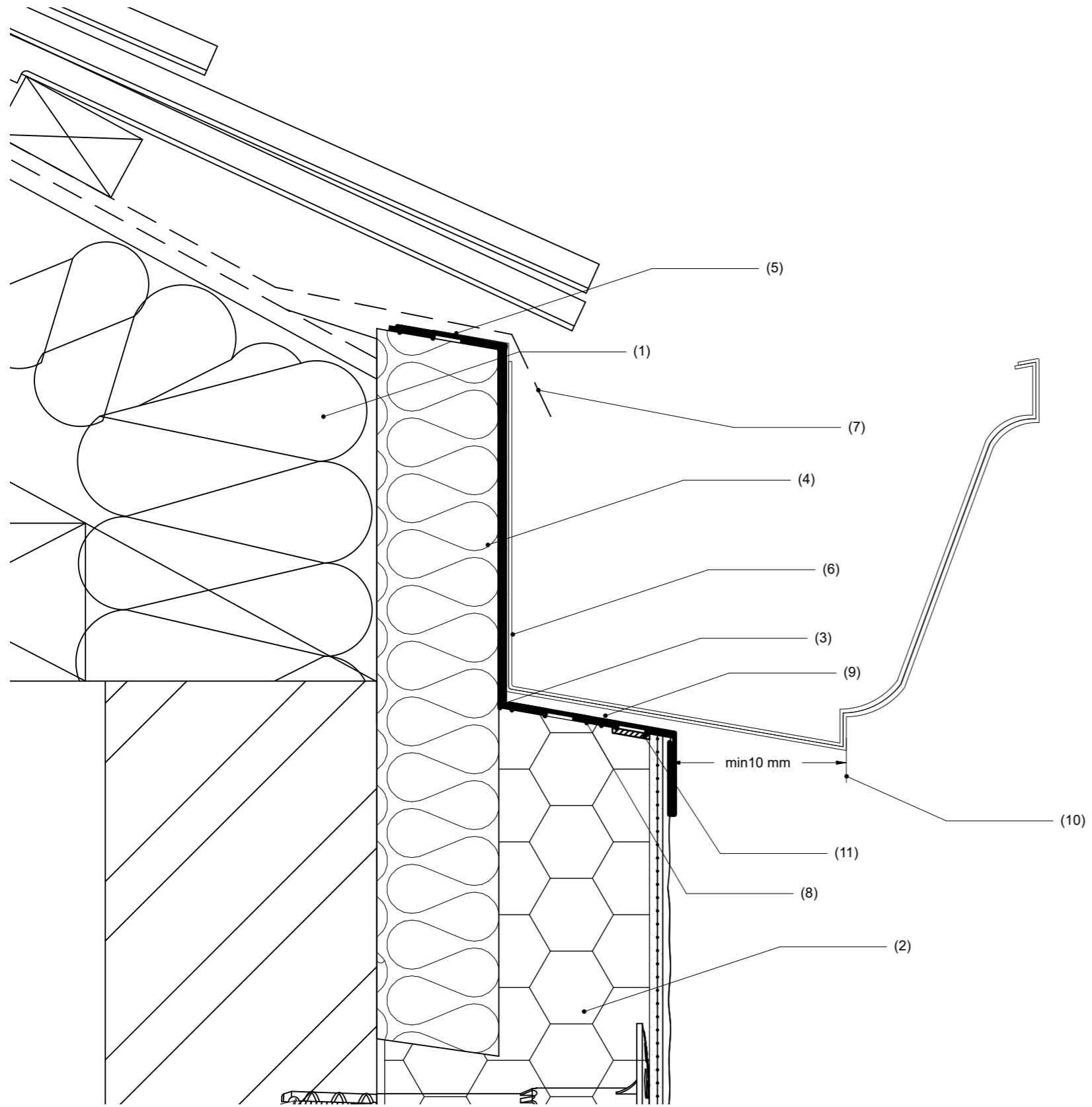

- (1) Existing fascia & gutter removed. Insulation packed between rafter feet;
- (2) Top of insulation board chamfered to match fall of gutter;
- (3) Waterproof membrane with minimum 100 mm laps at all joints. Joints offset (min 100 mm) from joints in gutter. Membrane to have positive fall away from roof;
- (4) Thermal insulation (min. $0.6 \text{ m}^2\text{K/W}$), **See Note Below.**
- (5) Gutter profile;
- (6) Gutter union double sealed (e.g. butyl or silicone sealant) with min. 40 mm overlap on each side of the joint;
- (7) Sarking/roof felt dressed into gutter;
- (8) Membrane fixed to top of EWI system.
- (9) No seal between underside of gutter and top of membrane (maintain water egress pathway);
- (10) Minimum 10 mm gutter projection from face of render.
- (11) Double seal between render abutment and membrane under gutter profile.

Note A: Ventilation zone should be at least 25mm and should be continuous up to the Apex, in line with BS EN 5250 guidance Note B: Insulation types to achieve 0.6W/mk are; 20mm EPS at $0.031 = 0.645$, 30mm XPS at $0.035 = 0.857$

Title : FLUSH EAVES - INSULATED FLASHING WITH INTEGRATED GUTTER :

| | |
|----------------|--------|
| RCS Detail 2 : | |
| | Rev 1. |

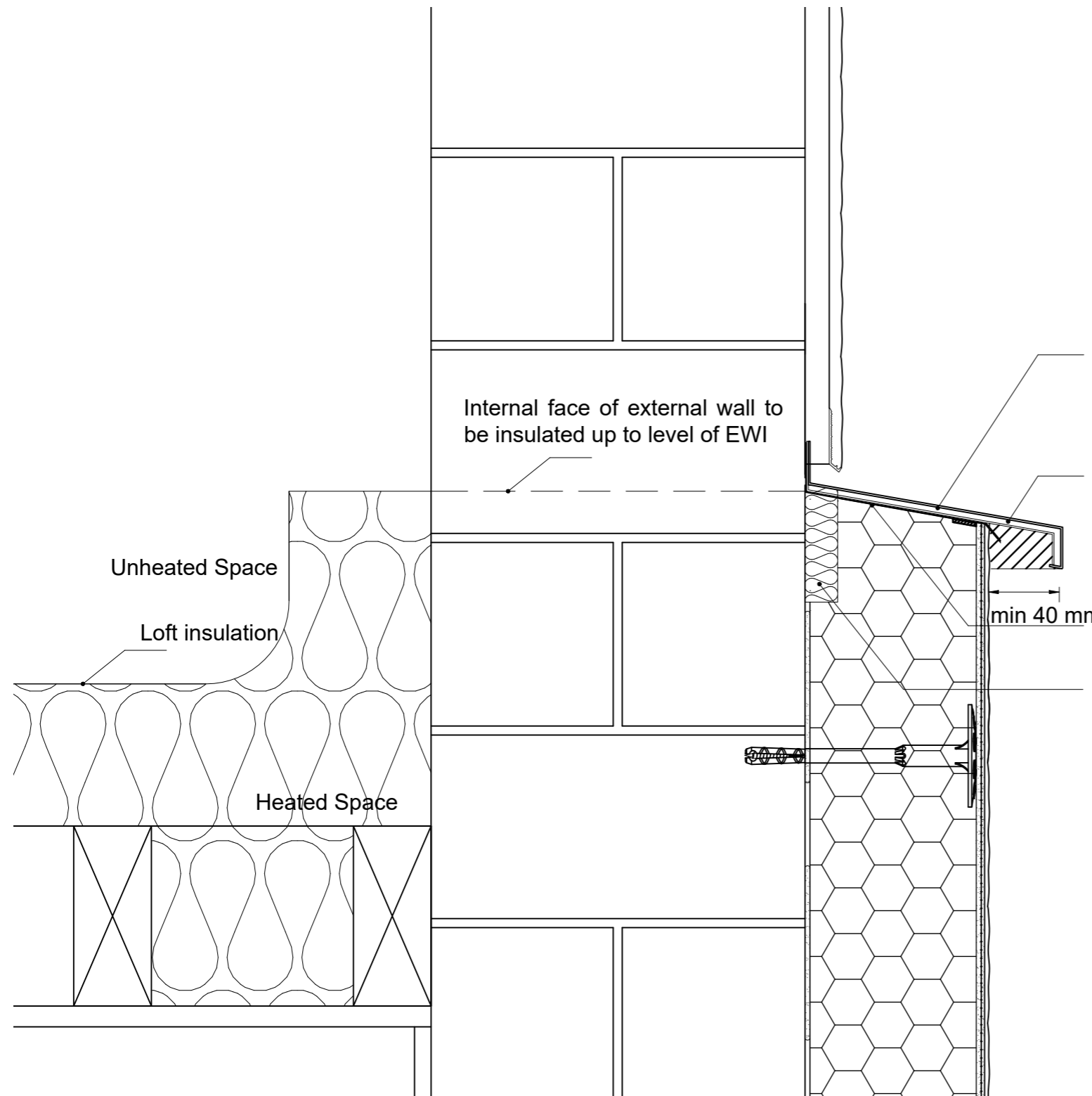

Internal face of external wall to be insulated up to level of EWI

Unheated Space

Loft insulation

Heated Space

min 40 mm

Metal profile fitted immediately below existing weatherboarding/tiles with upstand sealed to the wall face. Minimum 10° fall away from wall. Note: bottom rows of tiles/weatherboarding may need to be removed to enable EWI system to extend further up the wall in accordance with Retrofit Designer's requirements

Connections between adjacent sections of metal profiles must incorporate an under- or over-connector that extends min. 40 mm on each side of the joint. Connectors must be sealed to both sections of the metal profile using proprietary sealing tapes or proprietary sealants that must extend the full depth of the profile. Joints between primary seals and secondary seals shall be offset/staggered by min. 100 mm.

Waterproof membrane with minimum 100 mm laps at all joints. Joints offset (min 200 mm) from joints in metal flashing

EWI system has to be extended to a height that is not less than the height of the loft insulation

Thermal insulation ($R \geq 0.6 \text{ m}^2\text{K/W}$) between metal profile and substrate.

Title : TILE-HUNG or WEATHERBOARDED GABLE APEX - SOLUTION GUTTER PROFILE

RCS Detail 3 :

Rev 1.

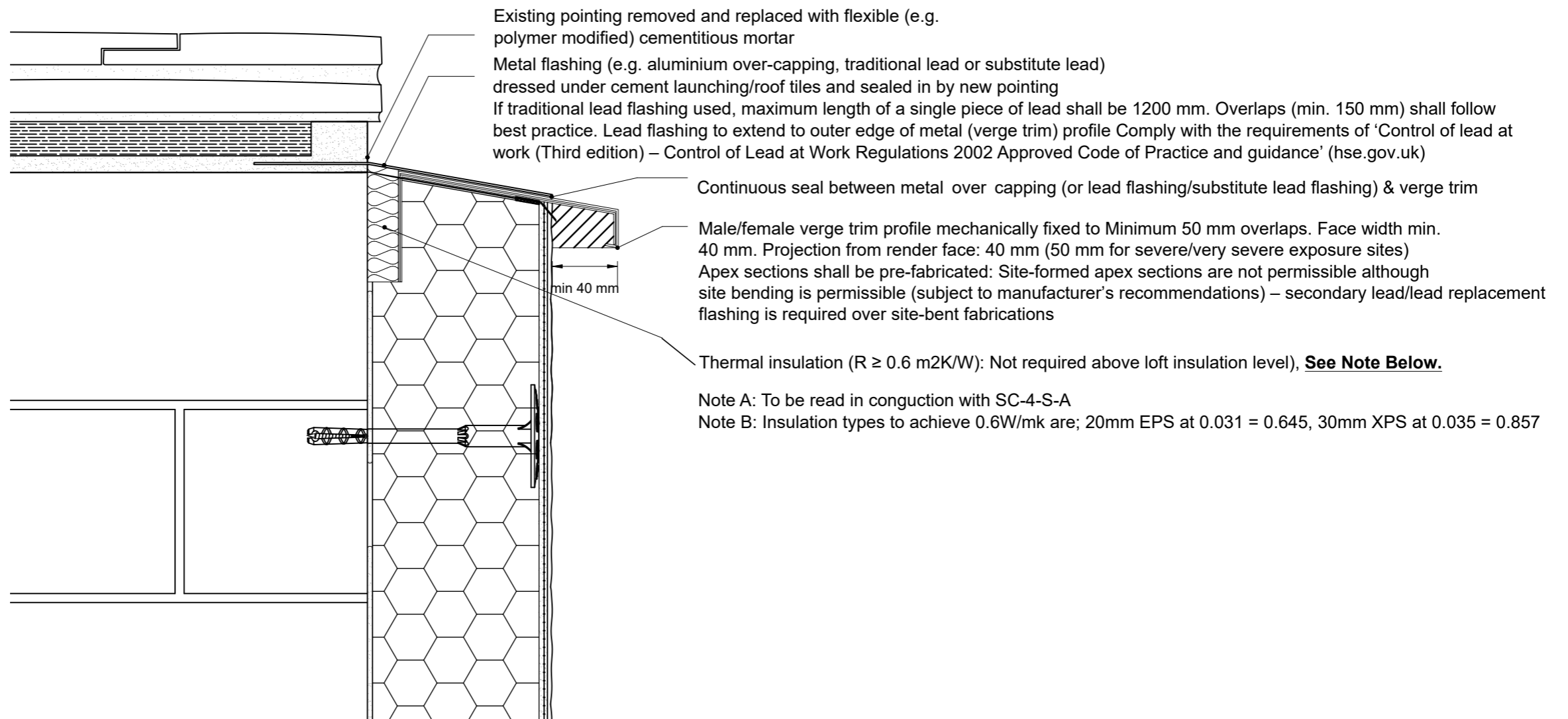

Title : FLUSH GABLE VERGE FOLLOWING APEX - VERGE TRIM WITH OVERCAPPING PROFILE

RCS Detail 4 :

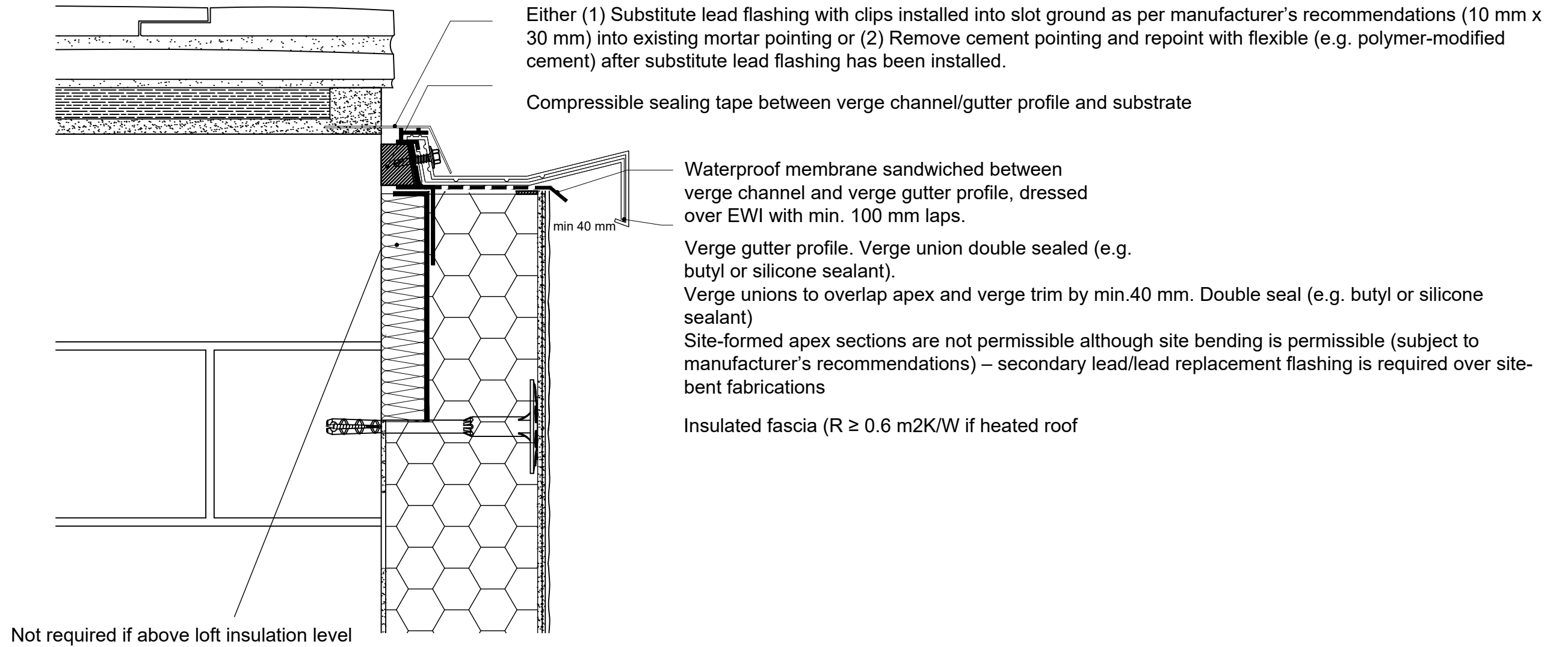

Title : FLUSH GABLE VERGE FOLLOWING APEX VERGE / GUTTER PROFILE

RCS Detail 5 :

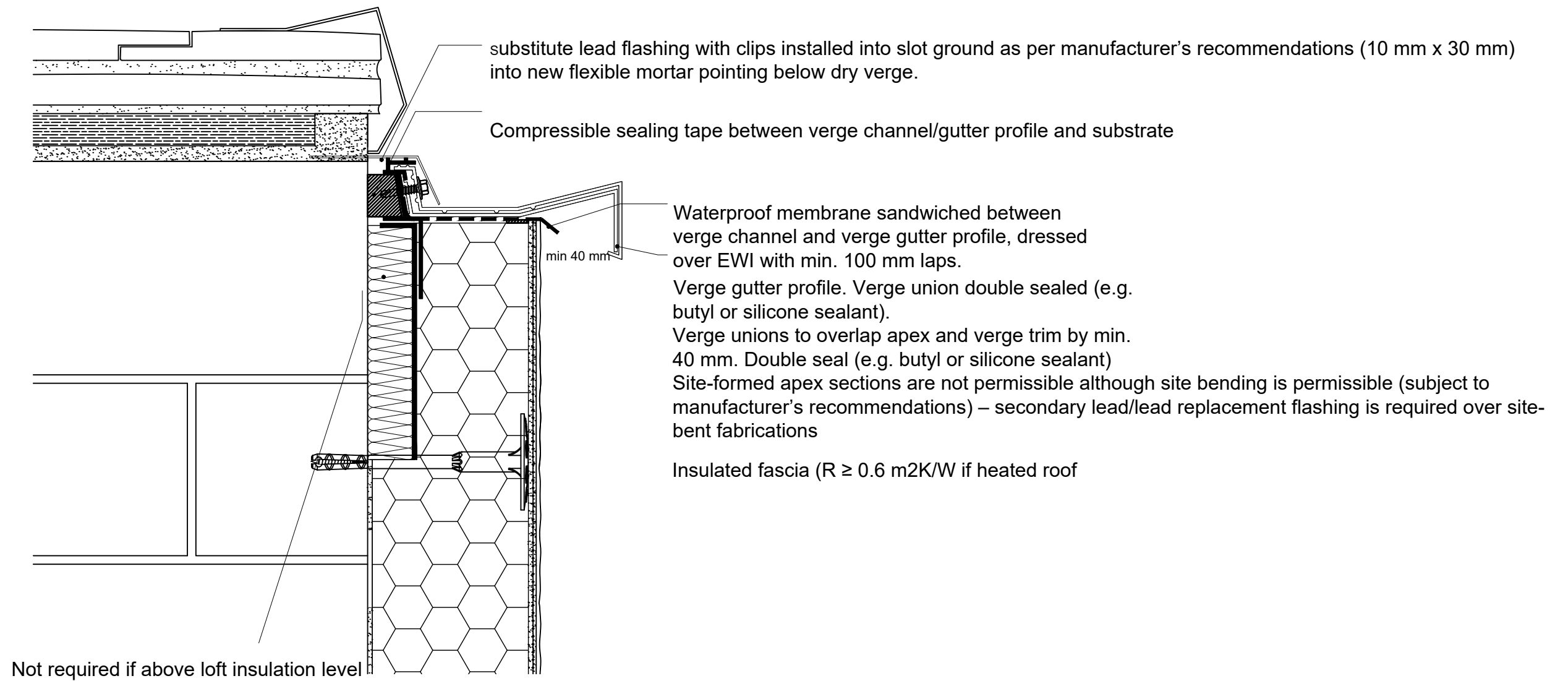

TITLE: VERGE FOLLOWING APEX (DRY VERGE) VERGE / GUTTER PROFILE

RCS Detail 6 :

Rev 1.

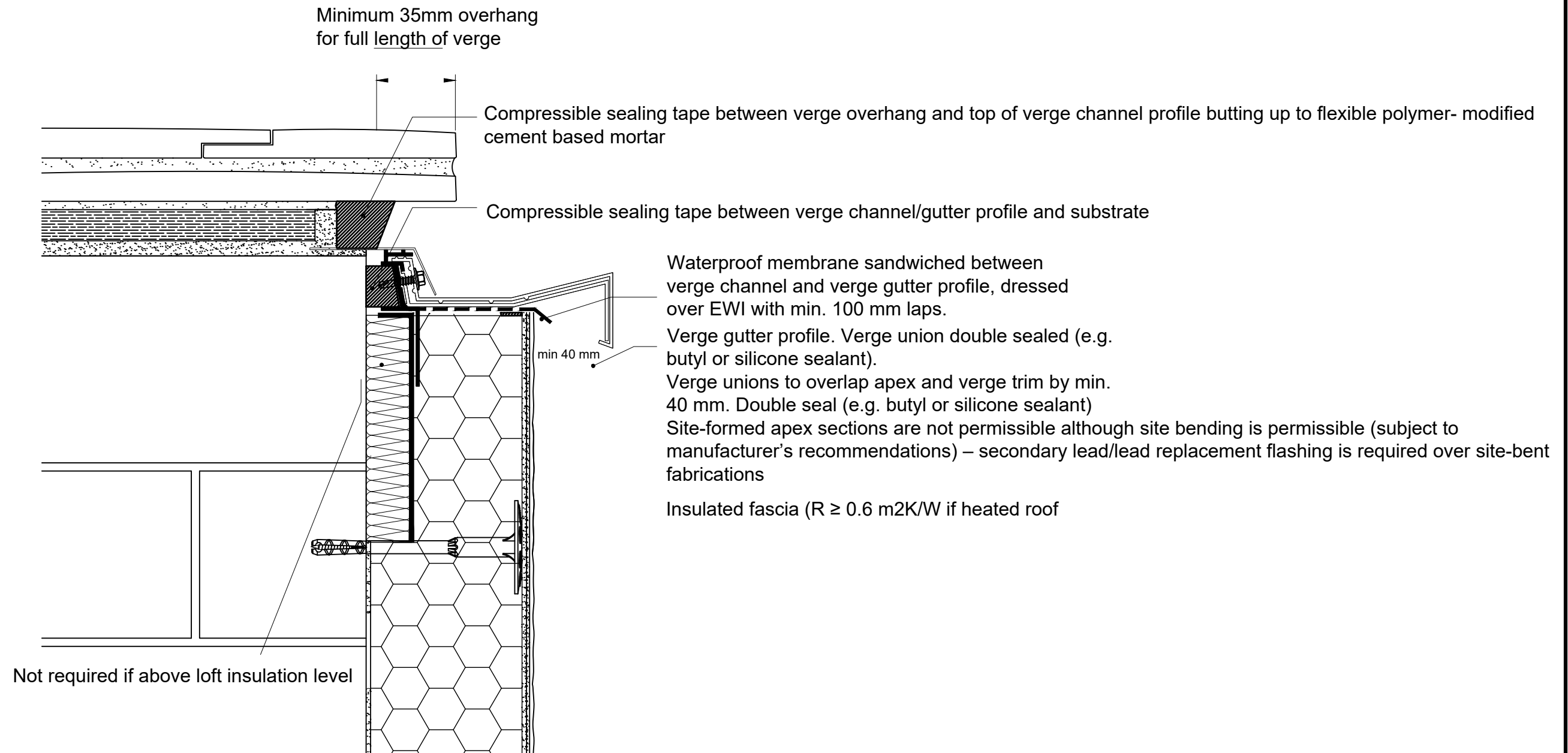

Title : OVERHANGING GABLE VERGE FOLLOWING APEX VERGE / GUTTER PROFILE

RCS Detail 7 :

Rev. 1

Roof Closure / Roof Extension Profile: Principles of design

- Pre-formed apex section: Site-formed apex sections are not permissible although site bending is permissible (subject to manufacturer's recommendations) – secondary lead/lead replacement flashing is required over site-bent fabrications
- Apex section overlaps middle section (min 50 mm) / Middle section overlaps lower section (min 50 mm)
- Mechanically fixed to wall to resist wind uplift
- Over-capped with lead/substitute lead or aluminium flashing dressed into brickwork/new cement (polymer modified) flashing. Overcapping either continuous (full length of verge) or segmented with min. 50 mm overlaps & seals at all joints

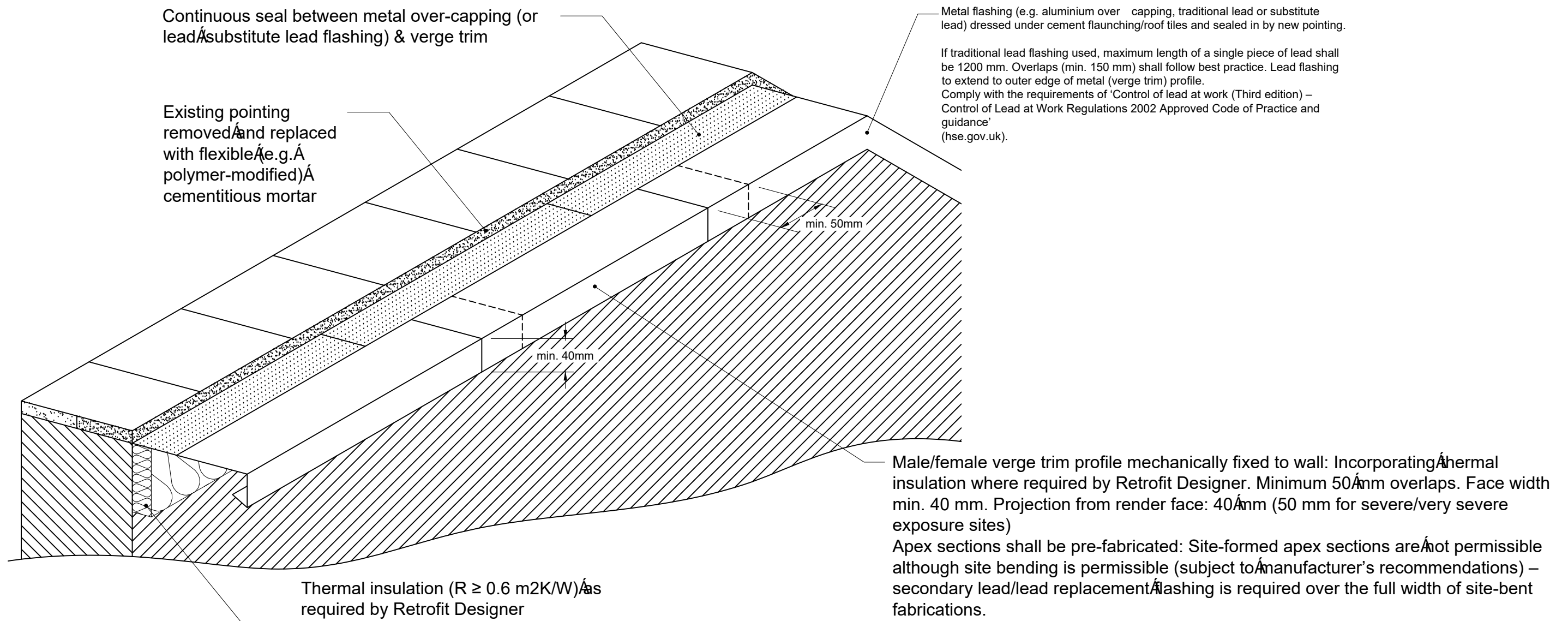

Metal flashing (e.g. aluminium over capping, traditional lead or substitute lead) dressed under cement flashing/roof tiles and sealed in by new pointing.

If traditional lead flashing used, maximum length of a single piece of lead shall be 1200 mm. Overlaps (min. 150 mm) shall follow best practice. Lead flashing to extend to outer edge of metal (verge trim) profile. Comply with the requirements of 'Control of lead at work (Third edition) – Control of Lead at Work Regulations 2002 Approved Code of Practice and guidance' (hse.gov.uk).

Title : VERGE APEX - IMPROVED ROOFLINE CLOSURE - PRE-FORMED APEX

RCS Detail 8 :

Rev 1.

Verge gutter profile / Roof Extension Profile: Principles of design

- Pre-formed Apex section
- Verge Unions to overlap Apex and Verge gutter profile by 40mm
- Mechanically fixed to wall to resist wind uplift
- integrated system (backed by thermal insulation as required)
- Water-tight connections with silicone sealant and waterproof membrane to provide primary and secondary seals.
- Joints in verge profile to be offset by min. 100mm from joints in membrane.
- Double sealed between render abutment and membrane under verge profile
- Lead replacement flashing securely fixed as per manufacturers recommendations into masonry or below cement pointing.

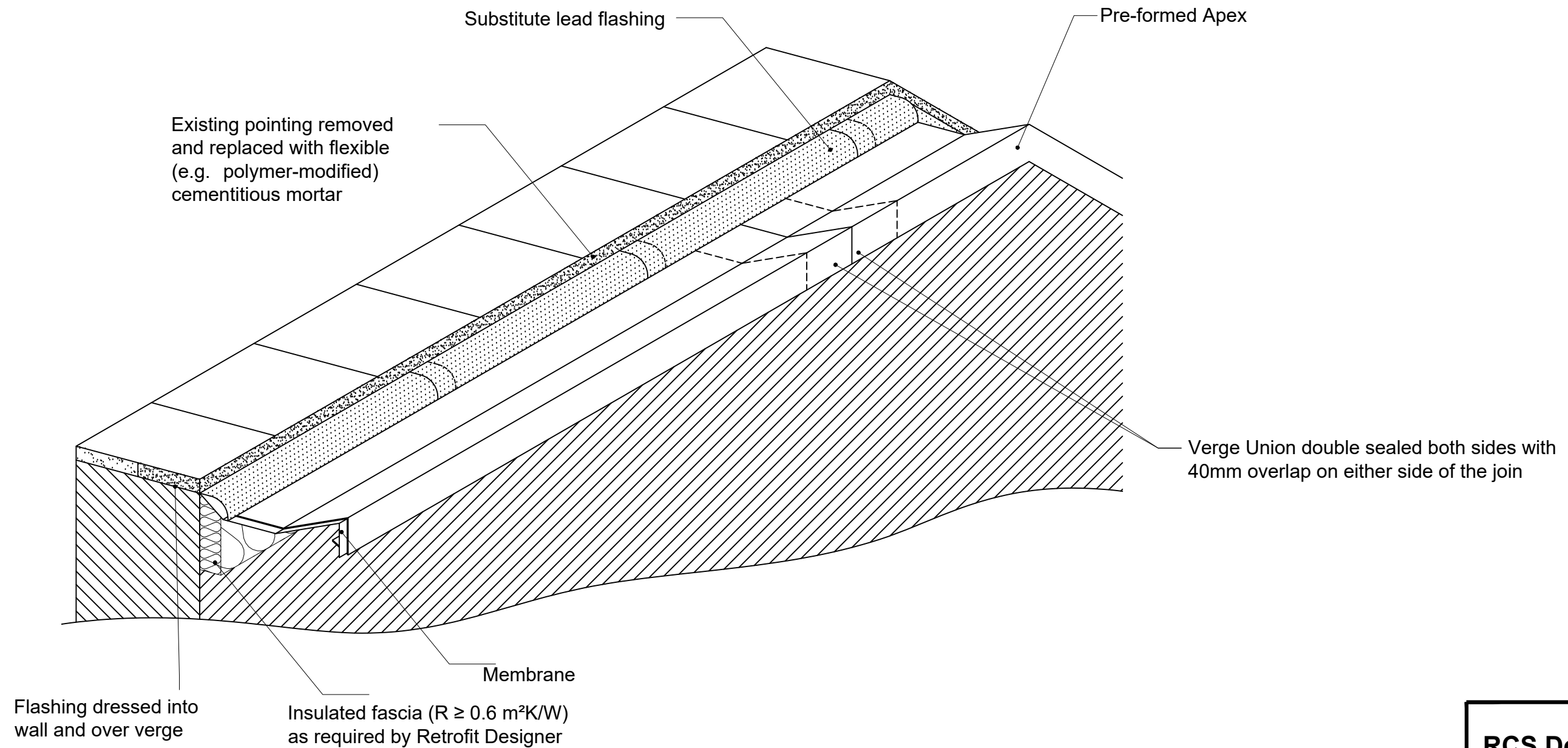

Title : VERGE APEX VERGE GUTTER PROFILE - PRE-FORMED APEX

RCS Detail 9 :

Rev 1

Verge gutter profile / Roof Extension Profile: Principles of design

- Site-formed apex sections are not permissible although site bending is permissible (subject to manufacturer's recommendations) – secondary lead/lead replacement flashing is required over site-bent fabrications
- Verge Unions to overlap Apex and Verge gutter profile by 40mm
- Mechanically fixed to wall to resist wind uplift
- Integrated system (backed by thermal insulation as required)
- Water-tight connections with silicone sealant and waterproof membrane to provide primary and secondary seals.
- Joints in verge profile to be offset by min. 100mm from joints in membrane.
- Double sealed between render abutment and membrane under verge profile
- Lead replacement flashing securely fixed as per manufacturers recommendations into masonry or below cement pointing.

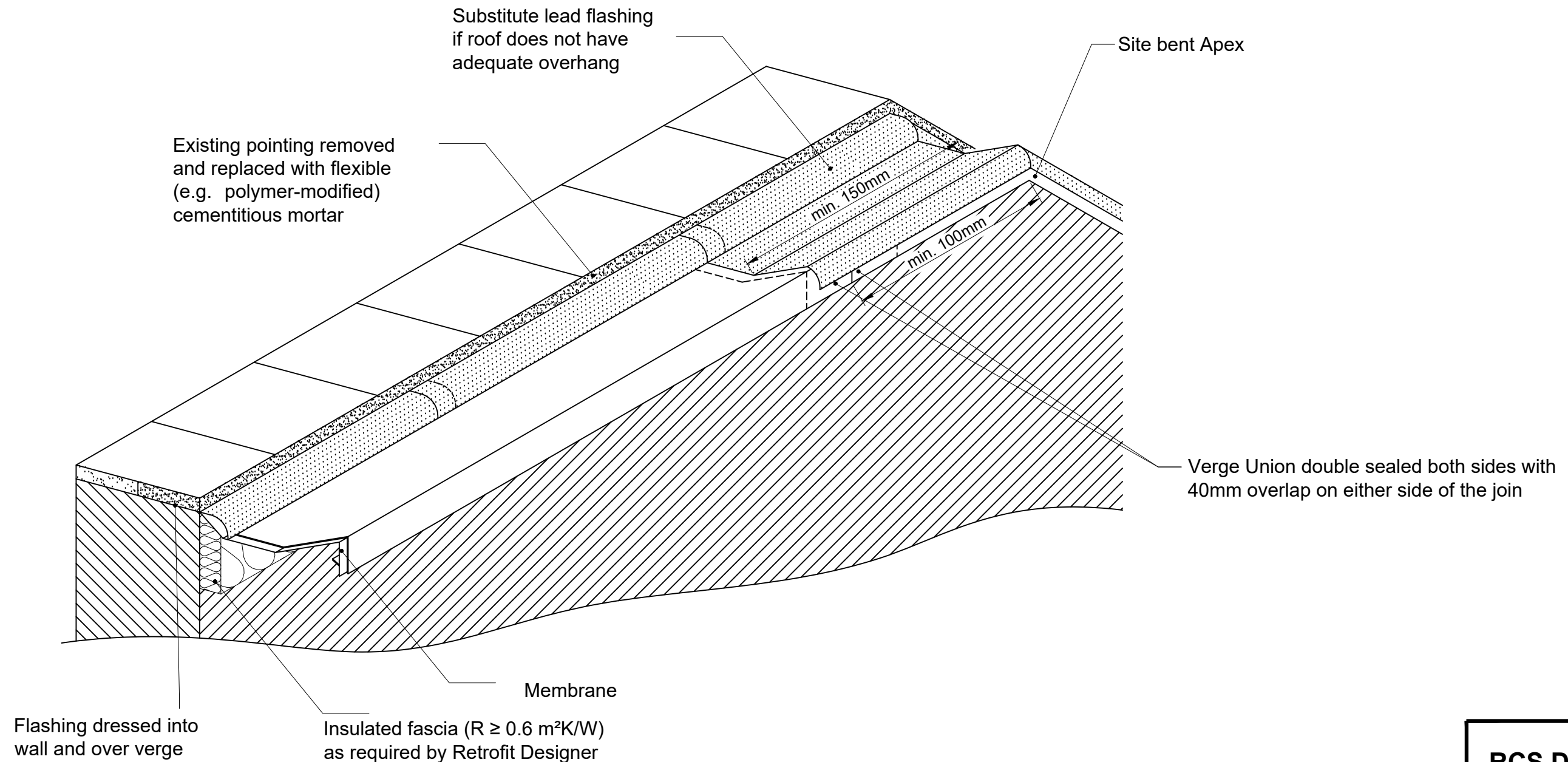

Title : VERGE APEX - VERGE GUTTER PROFILE - SITE FORMED APEX

RCS Detail 10 :

Rev 1.

- Thermal Bridge mitigation ($R \geq 0.6 \text{ m}^2\text{K/W}$) as per Retrofit Designer requirements.
- Multiple layers of water-ingress prevention.
- Integrated system (backed by thermal insulation as required)
- Water-tight connections with silicone sealant and waterproof membrane to provide primary and secondary seals.
- Membrane to be sloped to provide drainage away from building.
- Joints in verge profile to be offset by min. 100mm from joints in membrane.
- Double sealed between render abutment and membrane under verge profile
- Lead replacement flashing securely fixed as per manufacturers recommendations into masonry
- Gutter downpipes installed in front of system so no requirement for swan neck boxes

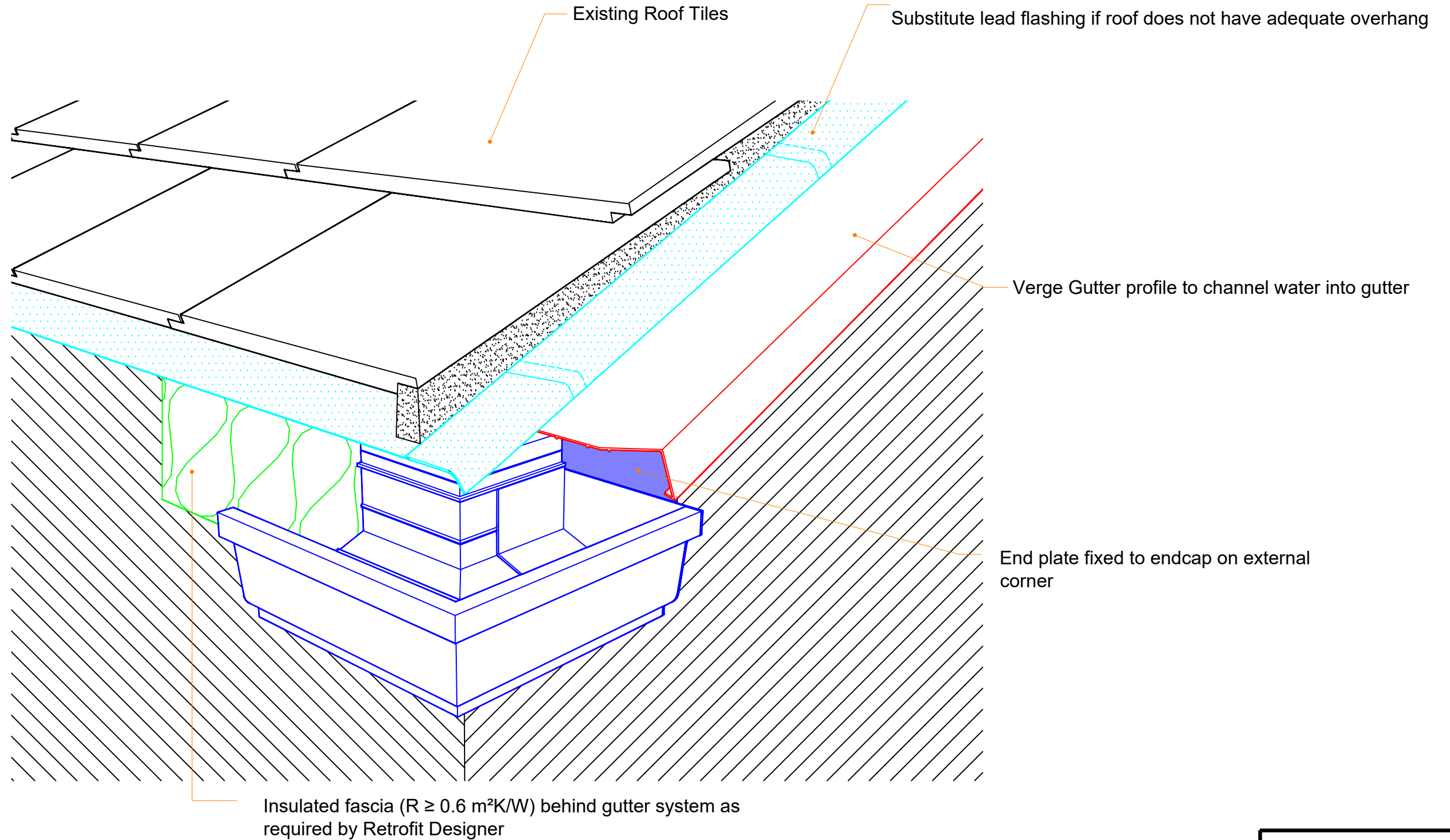

Title : Verge to Eaves connection

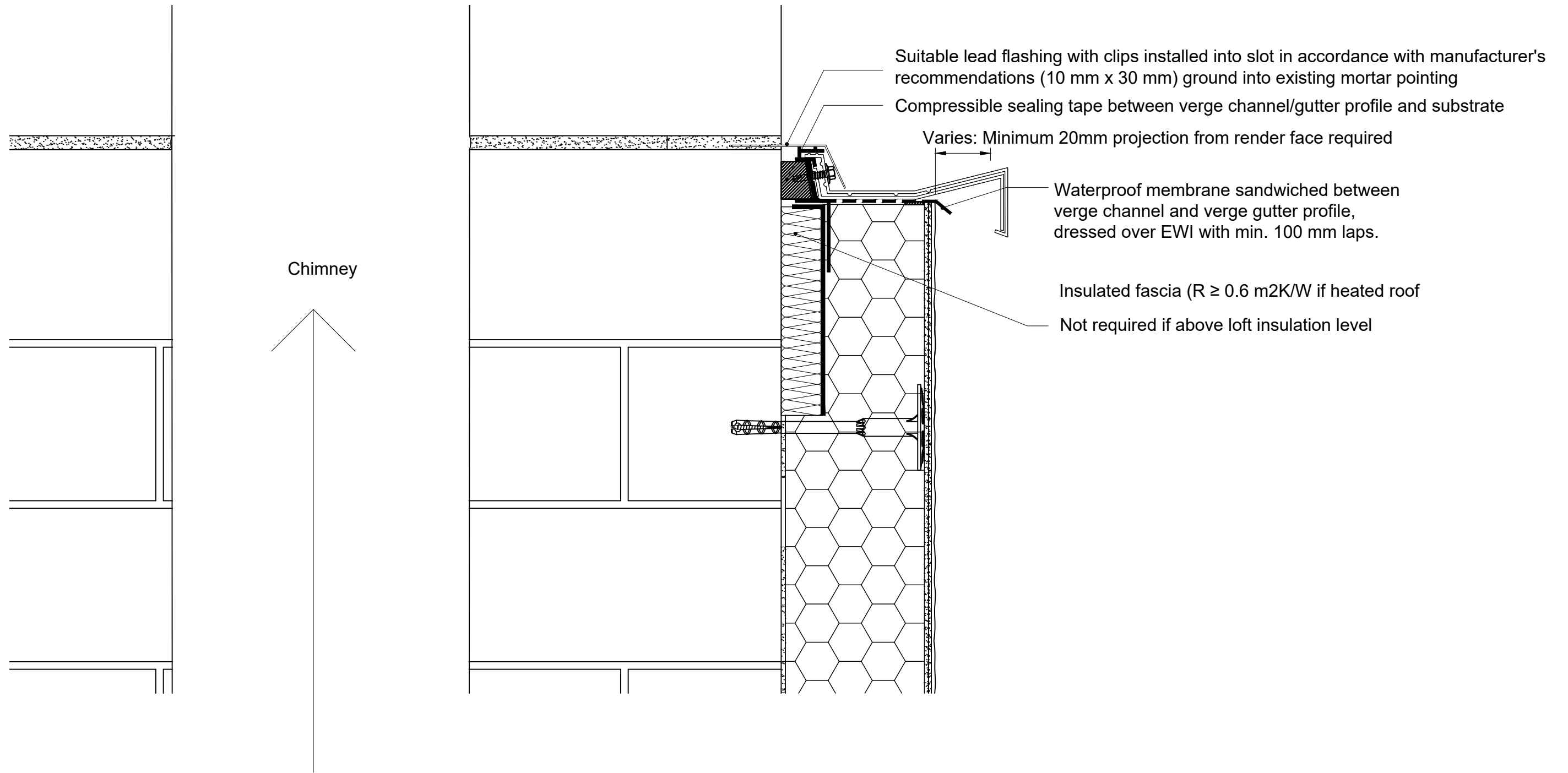

Title : GABLE CHIMNEYS GUTTER CHANNEL

RCS Detail 12 :

Rev 1.

Formed corner to be installed insulated and installed before gutter sections

Verge Unions to overlap by 40mm

Mechanically fixed behind gutter section

Available with insulation to help reduce the thermal transition

Water-tight connections with silicone sealant and waterproof membrane to provide primary and secondary seals Joints in verge profile to be offset by min. 100mm from joints in membrane

Double sealed between render abutment and membrane under verge profile

Corner section with end cap only abuts the insulation and is sealed in place with clip on over lapping render clip. This prevents a cold spots and water ingress

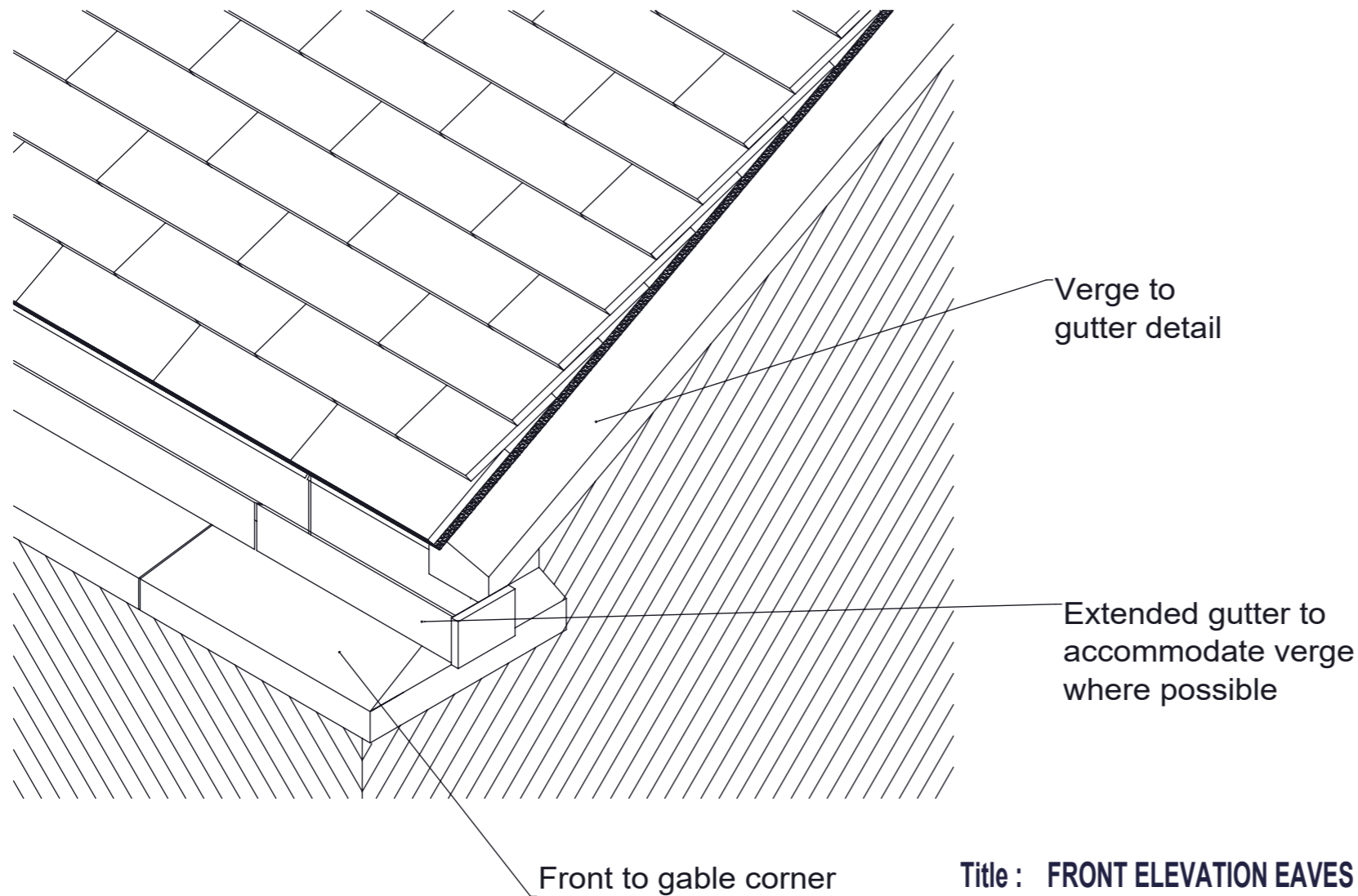
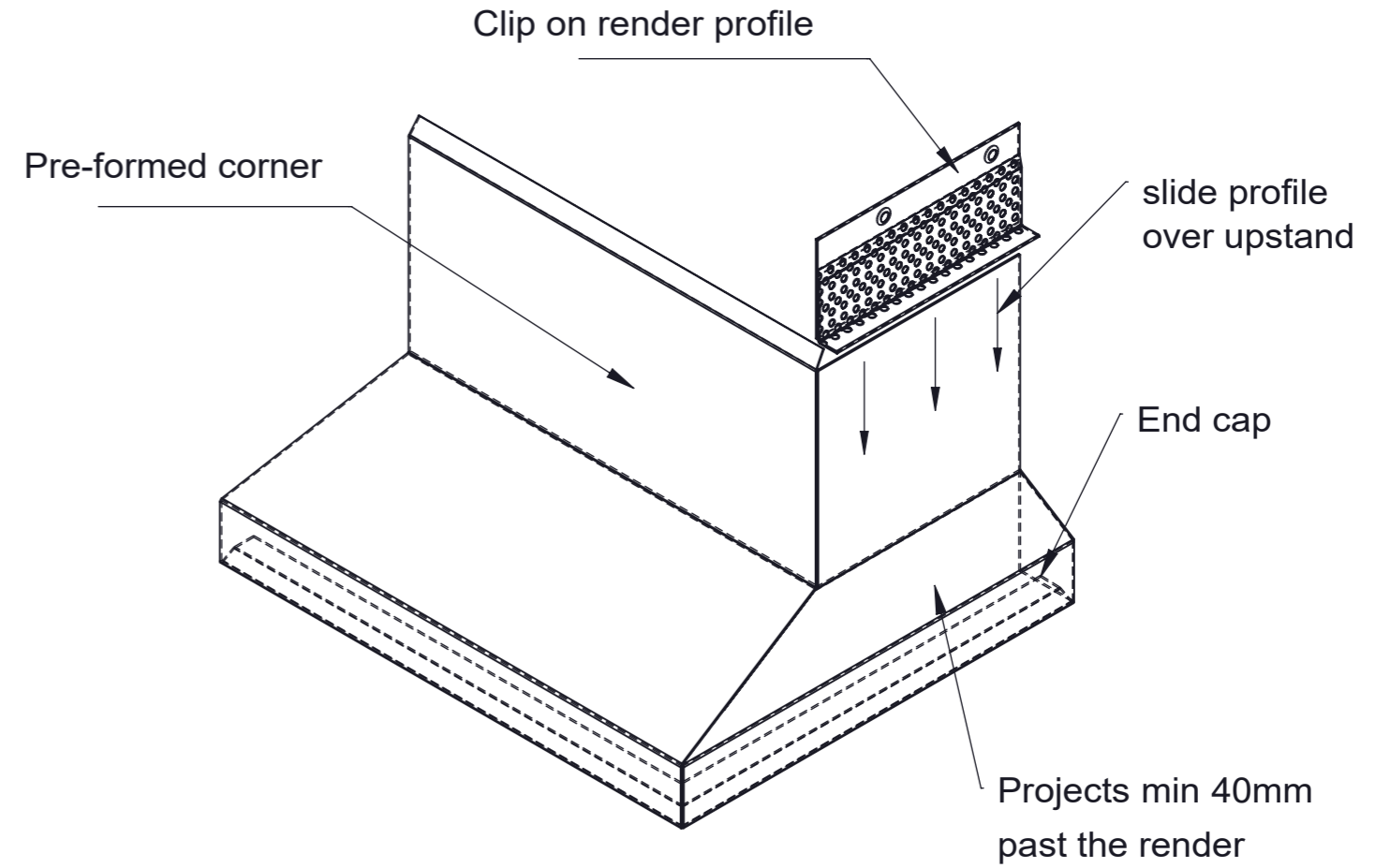

Title : FRONT ELEVATION EAVES TO GABLE CONNECTION -

RCS Detail 13 :

Design principles for roofline closure systems

These principles are a support tool for the roof closure details documented in the External wall insulation specification for weathering and thermal bridge control guide 2022. It is recognised that the details documented in this document are not exhaustive and therefore these principles are designed to be used to develop new Roof line closure solutions that comply with the PAS 2030 2019.

1. Redundancy of seals

At least two lines of weathering protection are required. Sealants shall not be employed to provide the primary barrier to water penetration. Additional redundancy can be achieved with an additional trim or suitable membrane. All joints must have a double seal to comply with the PAS requirements.

At eaves with insufficient roof overhang: Protection afforded to the top of the EWI system must include a secondary waterproof membrane and/or flashing that tucks under the existing sarking felt. Overhang must be appropriate for exposure zone, (40 mm moderate or sheltered exposure – 50 mm severe or very severe exposure) based on the BRE wind driven rain map in BR262 Thermal insulation: avoiding risks – [Appendix A: WP2 / \(publishing.service.gov.uk\)](#)

2. Gable-to-eaves junctions

Must be achieved with overlapping, prefabricated units/connectors: Site fabrication is not permissible though minor site trimming is permissible. Any joints between the primary and secondary seal must be staggered by 100 mm. Insulation to be maintained in corner of gable wall up to level of loft insulation as per Retrofit Designer requirements.

3. Gable apices

Must be formed using prefabricated elements: Site bent flashing can be utilised however secondary lead/lead replacement flashing required over the apex. Site-formed mitre joints using two separate profiles are not permissible.

4. Connections between adjacent sections of roofline closure systems

Must incorporate an under- or over connector that extends min. 40 mm on each side of the joint. Connectors must be sealed to both sections of the metal profile (roof closure, etc) using proprietary sealing tapes or proprietary sealants that must extend for the full width of the trim. Any joints between the primary and secondary seal must be staggered by 100 mm.

5. Use of Lead for flashing

If using lead as a solution the maximum length in a single piece should be 1200 mm and overlaps should follow best practice. Ensure health and safety requirements are complied with [Control of lead at work \(Third edition\) - Control of Lead at Work Regulations 2002 Approved Code of Practice and guidance \(hse.gov.uk\)](#) If Lead replacement flashings are used, these should be securely fixed in accordance with the manufacturer's recommendations.

6. Soffit/roof overhangs

A minimum 40 mm (50 mm for high exposure) is required, if less then trims/flashings should be embedded into the masonry, or below the cement pointing at verges and sealed. Any joints between a primary and secondary layer of redundancy must be overlapped by a minimum 100 mm. The sand and cement fillet should be replaced with a suitable flexible mortar.

7. weathering protection details

The installation of the weathering protection details must be separately included within the EWI system holder training that is provided to registered EWI installation contractors.

8. In all cases there should be continuity of the roof insulation and the insulated roofline closure solution to provide a minimum "thermal resistance of $0.6\text{m}^2\text{K/W}$ (and ensure no thermal bridging).

9. Roofline closure details that do not meet the requirements above are not acceptable for use with any funded or private schemes.

Minimum Material Specification for roofline closure system trims

To ensure a minimum quality is maintained when designing and installing a roofline closure system a minimum specification for the trims has been developed. The trials that were undertaken used the minimum specification and all future installations that follow either the standard details in this document, or, adhere to the minimum principles if designing a unique closure system must follow this minimum specification.

- **Suitable Base material:**

Minimum Aluminium specifications 1050A – Other higher grades are acceptable – 3000/5000.

Minimum Stainless-Steel specifications 304 – Other higher grades are acceptable – 316.

- **Minimum thickness:**

1.2 mm aluminium with a tolerance of +/- 10% to be used for trim widths up to 160 mm. For trim widths over 160 mm or trims to be used in exposed areas, (minimum 50 mm overhang) 1.5 mm aluminium must be considered for added strength and stability.

- **Coating requirement:**

Polyester Powder coated aluminium must have a minimum coating thickness of 40 microns to BS or Qualicoat standards and Powder Coaters must be BS or Qualicoat approved applicators. Pre-coated aluminium must be polyester coated on both sides and the thickness must conform to EN 13523-1. In areas exposed to severe wind driven rain (Zone 4 of BRE wind driven rain map) or directly facing the coast, a marine specification coating should be considered.